

**PackLite™ Power Amplifier
Model A1
(120V and 220-240V versions)**



CONTENTS

Safety Information	2
Warranty	2
Product Description	3
Carton Contents	3
Amplifier Rear Panel Connections and Controls	4
Top Panel Indicators	4
Setting Up a Single A1 Amplifier	5
Using Multiple A1 Amplifiers	6
Using the A1 in other applications	7
Setting up the A1 for use with other systems:	7
Specifications	8
Production Notes	9
Electrostatic Discharge Sensitive (ESDS) Device Handling	9
Part List Notes	9
Packaging Part List, PackLite™ A1 Amplifier Assembly (see Figure 1)	10
Figure 1. PackLite A1 Amplifier Assembly Packaging View	10
Main Part List, PackLite A1 Amplifier Assembly (see Figure 2)	11
Figure 2. PackLite A1 Amplifier Exploded View	12
Electrical Part Lists	13-29
Power Supply / Amplifier PCB Assembly	13-22
Input / Limiter PCB Assembly	23-28
Signal LED PCB Assembly	29
Power / Fault LED PCB Assembly	29
Disassembly Procedures	30-33
Test Procedures	33-34
Figure 3. Amplifier/SMPS PCB (Non-RoHS) Topside Etch Layout	35
Figure 4. Amplifier/SMPS PCB (Non-RoHS) Internal Etch Layer 1 Layout	35
Figure 5. Amplifier/SMPS PCB (Non-RoHS) Internal Etch Layer 2 Layout	36
Figure 6. Amplifier/SMPS PCB (Non-RoHS) Bottom Etch Layout	36
Figure 7. Amplifier/SMPS PCB (RoHS) Topside Etch Layout	37
Figure 8. Amplifier/SMPS PCB (RoHS) Internal Etch Layer 1 Layout	37
Figure 9. Amplifier/SMPS PCB (RoHS) Internal Etch Layer 2 Layout	38
Figure 10. Amplifier/SMPS PCB (RoHS) Bottom Etch Layout	38
Figure 11. Input/Limiter PCB (Non-RoHS) Top Side Etch Layout	39
Figure 12. Input/Limiter PCB (Non-RoHS) Bottom Side Etch Layout	39
Figure 13. Input/Limiter PCB (RoHS) Top Side Etch Layout	40
Figure 14. Input/Limiter PCB (RoHS) Bottom Side Etch Layout	40
Figure 15. Power/Fault LED PCB Etch Layout	41
Figure 16. Signal/Overload LED PCB Etch Layout	41
Test Cable Wiring Diagrams	41
Troubleshooting	42
Theory of Operation, PackLite Model A1 Amplifier	43-50
Integrated Circuit Diagrams	51-53
Service Manual Revision History	54

SAFETY INFORMATION

1. Parts that have special safety characteristics are identified by the  symbol on schematics or by special notes on the parts list. Use only replacement parts that have critical characteristics recommended by the manufacturer.
2. Make leakage current or resistance measurements to determine that exposed parts are acceptably insulated from the supply circuit before returning the unit to the customer. Use the following checks to perform these measurements:

A. Leakage Current Hot Check-With the unit completely reassembled, plug the AC line cord directly into a 120V AC outlet. (Do not use an isolation transformer during this test.) Use a leakage current tester or a metering system that complies with American National Standards Institute (ANSI) C101.1 "Leakage Current for Appliances" and Underwriters Laboratories (UL) UL6500 / UL60065 / IEC 60065 paragraph 9.1.1. With the unit AC switch first in the ON position and then in OFF position, measure from a known earth ground (metal waterpipe, conduit, etc.) to all exposed metal parts of the unit (antennas, handle bracket, metal cabinet, screwheads, metallic overlays, control shafts, etc.), especially any exposed metal parts that offer an electrical return path to the chassis. Any current measured must not exceed 0.5 milliamp. Reverse the unit power cord plug in the outlet and repeat test. ANY MEASUREMENTS NOT WITHIN THE LIMITS SPECIFIED HEREIN INDICATE A POTENTIAL SHOCK HAZARD THAT MUST BE ELIMINATED BEFORE RETURNING THE UNIT TO THE CUSTOMER.

B. Insulation Resistance Test Cold Check-(1) Unplug the power supply and connect a jumper wire between the two prongs of the plug. (2) Turn on the power switch of the unit. (3) Measure the resistance with an ohmmeter between the jumpered AC plug and each exposed metallic cabinet part on the unit. When testing 3 wire products, the resistance measured to the product enclosure should be between 2 and infinite MOhms. Also, the resistance measured to exposed input/output connectors should be between 4 and infinite MOhms. When testing 2 wire products, the resistance measured to exposed input/output connectors should be between 4 and infinite MOhms. If it is not within the limits specified, there is the possibility of a shock hazard, and the unit must be repaired and rechecked before it is returned to the customer.

CAUTION: The Bose® PackLite™ Model A1 Amplifier contains no user-serviceable parts. To prevent warranty infractions, refer servicing to warranty service stations or factory service.

PROPRIETARY INFORMATION

THIS DOCUMENT CONTAINS PROPRIETARY INFORMATION OF BOSE CORPORATION WHICH IS BEING FURNISHED ONLY FOR THE PURPOSE OF SERVICING THE IDENTIFIED BOSE PRODUCT BY AN AUTHORIZED BOSE SERVICE CENTER OR OWNER OF THE BOSE PRODUCT, AND SHALL NOT BE REPRODUCED OR USED FOR ANY OTHER PURPOSE.

WARRANTY

The Bose PackLite Model A1 Amplifier is covered by a limited 1-year transferable warranty.

Product Description

The PackLite™ Model A1 power amplifier is a small, lightweight, powerful, and easy-to-use amplifier that interfaces quickly with the Bose® PS1 power stand and B1 bass modules to provide high bass output for demanding instruments such as bass guitar and drums. The connections are quick and easy: plug in the AC cord, connect the A1 to the PS1 power stand, and play. When the A1 is used together with the Cylindrical Radiator® loudspeaker, no time-consuming adjustments are required. The components act as a system and automatically adjust bass output for more level and headroom, while maintaining consistent tone regardless of how many B1 bass modules are being used.

In addition, the A1 can drive other passive loudspeakers such as bass guitar cabinets, subwoofers, studio monitors, and floor monitors.

Carton Contents

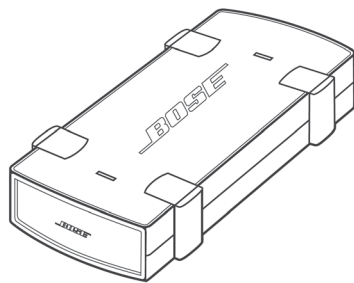

PackLite™ power amplifier Model A1



Carrying pouch



AC power cord*

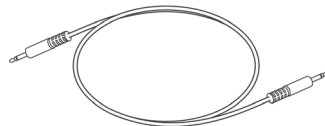

1/4" TRS (balanced) cable
(20 inches, 0.5 m)



Owner's guide

*The appropriate power cord for your region is provided.

- Carrying pouch
- PackLite power amplifier Model A1
- AC power cord
- 1/4" TRS (balanced) cable (20 inches, 0.5 m)
- Owner's guide

Amplifier Rear Panel Connections and Controls

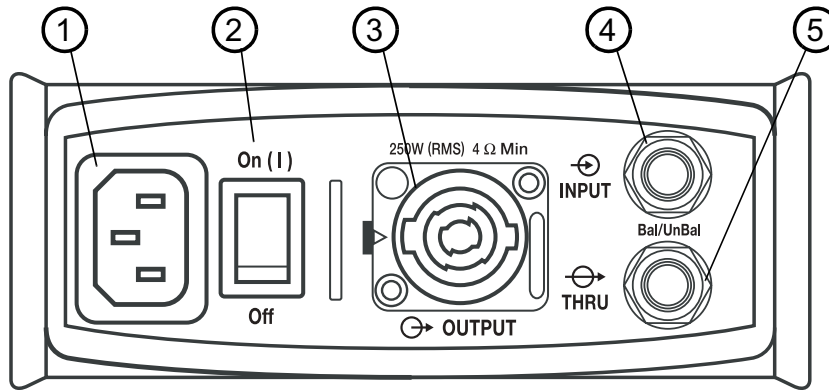

1 - AC power connector: Accommodates the supplied AC power cord to connect your amplifier to the appropriate AC (mains) outlet. Check the product label of your amplifier for the voltage rating: 120V or 220-240V.

2 - Power switch: In the ON (I) position, applies power to your amplifier. When ON, the power indicator (see diagram below) should be BLUE.

3 - OUTPUT connector: Accommodates both 2 and 4-wire Neutrik® Speakon® connectors. OUTPUT can be connected to any of the following:

- B1 bass module.
- 4-ohm loudspeaker with a power rating of at least 250W RMS.
- 8-ohm loudspeaker with a power rating of at least 125W RMS.

4 - INPUT connector: Accommodates a ¼" TRS (balanced) or TS (unbalanced) plug. INPUT can be connected to either of the following:

- Bass-Line OUT jack on the PS1 power stand using the supplied ¼" TRS cable.
- THRU connector of an "upstream" A1 amplifier when used in series.
- Other line-level source output using either a ¼" TRS or TS cable.

5 - THRU connector: Accommodates a ¼" TRS or TS connection. Used for sending the INPUT signal to another A1 amplifier.

Notes:

1. Do not use the THRU connector as a second input, as it could damage any interconnected equipment. Use THRU only as an output to another A1 amplifier.
2. The THRU connector will only relay the type of input (balanced or unbalanced) present at the INPUT connector.

Top Panel Indicators

The top panel of the A1 has two indicators that tell you the state of the amplifier.

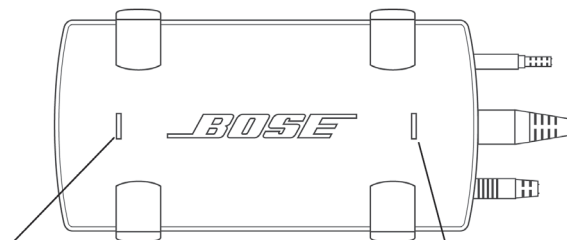

Signal indicator:

GREEN when a signal is present at the input.
RED when amplifier is over-driven and limiting function is activated to prevent damage to the connected loudspeaker.

Power indicator:

BLUE when amplifier is on and ready to use.

Setting Up a Single A1 Amplifier

The A1 amplifier is designed to add more bass output to a system that already has two B1 bass modules connected to the Amp 3 OUT connector on the PS1 power stand. The A1 amplifier can power up to two additional B1 bass modules.

Follow these steps to set up the A1 as shown below.

1. Connect the AC power cord to an AC (mains) outlet.
2. Make sure the A1 amplifier Power switch is OFF.
3. Using the supplied ¼" TRS cable, connect the Bass-Line OUT connector on the PS1 power stand to the INPUT connector on the A1 amplifier.
4. Connect a B1 bass module cable from the OUTPUT connector on the A1 to a B1 bass module. If desired, connect a second B1 to the first B1.
5. Set the A1 power switch to ON (I).

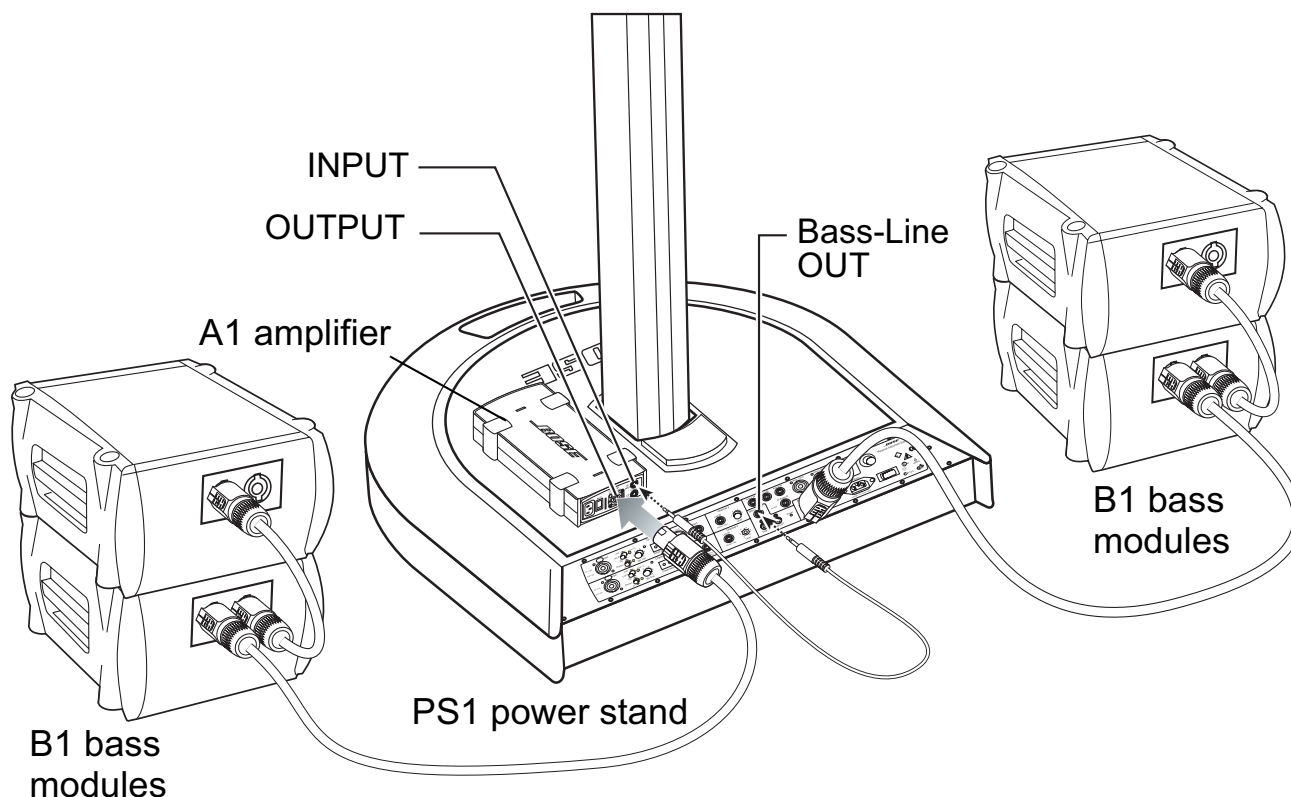

CAUTION: Do not connect more than two B1 bass modules to an A1 amplifier.

CAUTION: Be careful not to connect the A1 amplifier to a B1 bass module that is already connected to the Amp 3 OUT connector of a PS1 power stand, or to another A1 amplifier.

Note: Using the supplied ¼" TRS cable with your A1 amplifier is recommended. Using balanced cabling prevents common interconnect noise problems.

Note: Up to four (maximum) B1 bass modules can be stacked in a column. Stacking may improve acoustic output.

Using Multiple A1 Amplifiers

To add more bass capability to your system, you can connect multiple A1 amplifiers as shown below.

1. Connect the AC power cord to an AC (mains) outlet.
2. Make sure the Power switch is OFF.
3. Using the supplied ¼" TRS cable, connect the Bass-Line OUT connector on the PS1 power stand to the INPUT connector on the first A1 amplifier.
4. Using another ¼" TRS cable, connect the THRU connector on the first A1 amplifier to the INPUT connector of the next A1 amplifier.
5. Connect a B1 bass module to the OUTPUT connector on each A1 amplifier. If desired, connect a second B1 to the first B1.
6. Set power switch on both A1 amplifiers to ON (I).

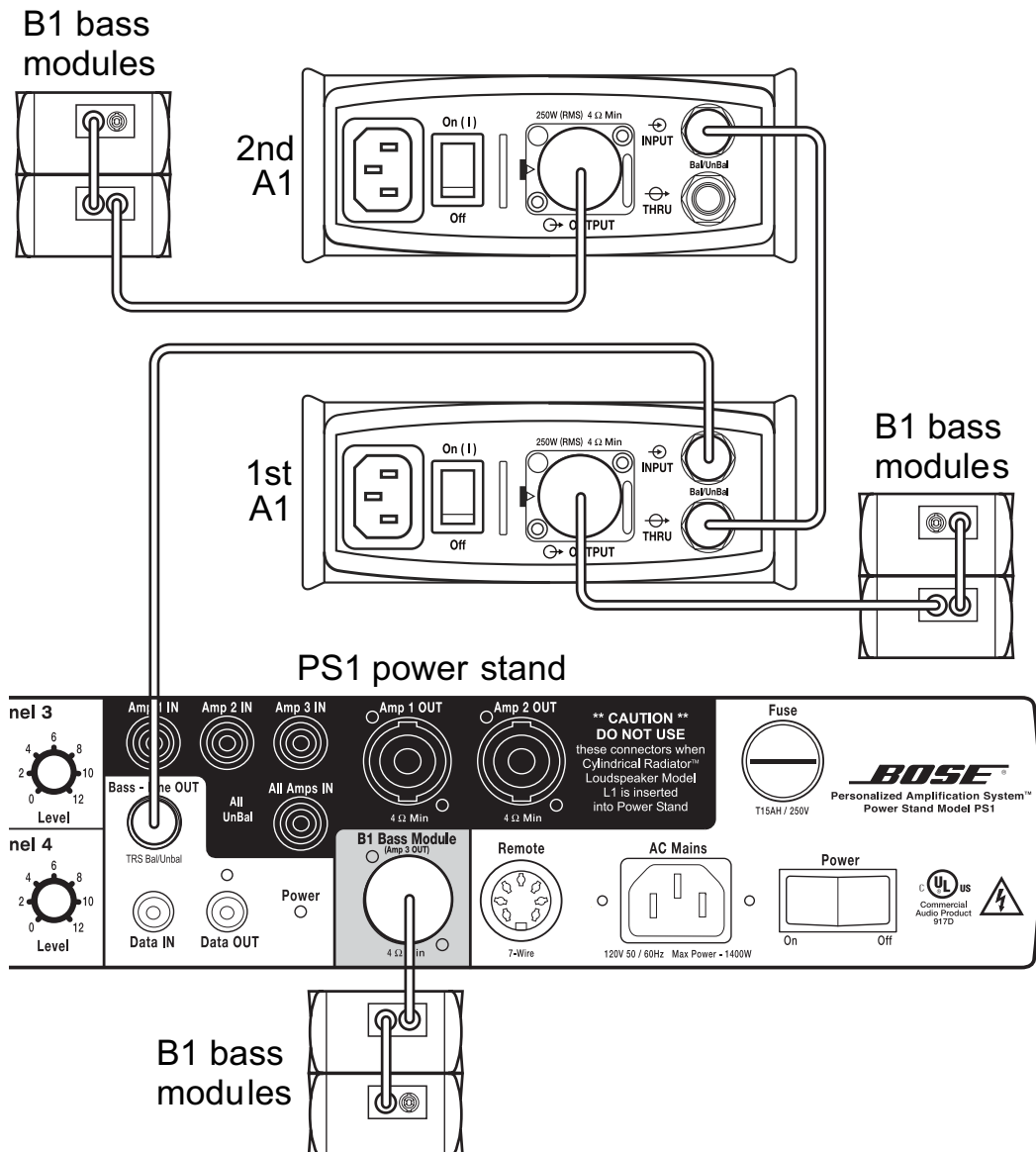

CAUTION: Be careful not to connect the A1 amplifier to a B1 bass module that is already connected to the Amp 3 OUT connector of a PS1 power stand or to another A1 amplifier.

Note: Up to four (maximum) B1 bass modules can be stacked in a column. Stacking may improve acoustic output.

Using the A1 in other applications

The A1 amplifier can be used as a power amplifier in other system configurations.

The A1 can drive other passive loudspeakers including subwoofers, floor monitors, studio monitors, and guitar cabinets. The A1 can amplify a balanced or unbalanced signal from a line-level device, such as a mixing console, and drive any loudspeaker load (4-ohm minimum) that is capable of handling 250W.

Setting up the A1 for use with other systems:

1. Make sure the A1 amplifier Power switch is OFF.
2. Connect a line-level output connector from your source device to the INPUT connector of the A1 amplifier.
 - This could be the line-level output from an electronic crossover, mixing console, electric bass/electric guitar amplifier head unit, preamp, digital modeler, or studio console line output.
 - You can use either a balanced (TRS) or unbalanced (TS) connection. The amplifier will sense the type of connection and automatically adjust the overall level.
3. Connect the OUTPUT of the A1 amplifier to:
 - Any 4-ohm loudspeaker load capable of handling at least 250 watts RMS.
 - Any 8-ohm loudspeaker load capable of handling at least 125 watts RMS.
4. If you want to add an additional A1 for more bass, connect the THRU connector of the first A1 to the INPUT connector of another A1 amplifier using a ¼" TRS cable.
5. Set the A1 power switch to ON (I).
6. Adjust the source level so that the A1 signal indicator flashes green. At a maximum source level, the A1 signal indicator occasionally flashes red. If the indicator is constantly red, reduce the source level.

Note: Using the A1 amplifier and its connected B1 bass modules with any source device other than the PS1 power stand is not recommended.

Specifications

Electrical

Power, 4-ohm load:	250 watts RMS (1 kHz, 0.1% THD)
Power, 8-ohm load:	125 watts RMS (1 kHz, 0.1% THD)
Minimum loudspeaker load:	4 Ohms
Signal to noise:	100 dB (20 Hz to 20 kHz)
Voltage gain:	30 dB
Input sensitivity:	1.15 V (+3.4 dBu)
Input sensing:	Automatic, balanced/unbalanced level adjust
Input impedance:	55k ohms unbalanced, 110k ohms balanced
Input clipping:	10 Vrms (+22 dBu)
Frequency response:	20 Hz to 20 kHz \pm 0.5 dB
THRU output type:	Balanced/unbalanced, dependent on INPUT connection type
Output circuitry:	Class D
Protection types:	Self-resetting thermal, output short circuit, and over-current
Typical AC power requirements:	1.8A, 120VAC; 0.9A, 220-240VAC
Peak inrush current:	28A (120VAC)

Mechanical

Dimensions:	5.6" W x 2.3" H x 10.3" D; 140 mm W x 56 mm H x 258 mm D
Weight:	3.0 lbs (1.4 kg)
Packaged Shipping Weight:	5.0 lbs (2.3 kg)
Max. operating temperature:	122°F (50°C)

PRODUCTION NOTES

The PackLite™ A1 amplifier has been manufactured in two versions, a 120V version (product code 039057) and a 220-240V version (product code 039058).

The early 120V units, serial numbers 039057Z52620201AC to 039057Z52621200AC, are non-RoHS compliant units. 120V units built after the 5262 Julian date (9/19/2005) are fully RoHS compliant.

The 220-240V version, product code 039058, is fully RoHS compliant from the initial production units onward.

The Electrical Parts Lists have non-RoHS and RoHS compliant part numbers in cases where these parts are different for the two versions of the amplifier. Be sure to use ONLY RoHS compliant repair parts in RoHS compliant products.

ELECTROSTATIC DISCHARGE SENSITIVE (ESDS) DEVICE HANDLING

This unit contains ESDS devices. We recommend the following precautions when repairing, replacing or transporting ESDS devices:

- Perform work at an electrically grounded work station.
- Wear wrist straps that connect to the station or heel straps that connect to conductive floor mats.
- Avoid touching the leads or contacts of ESDS devices or PC boards even if properly grounded. Handle boards by the edges only.
- Transport or store ESDS devices in ESD protective bags, bins, or totes. Do not insert unprotected devices into materials such as plastic, polystyrene foam, clear plastic bags, bubble wrap or plastic trays.

PART LIST NOTES

1. This part is not normally available from Customer Service. Approval from the Field Service Manager is required before ordering.
2. The individual parts located on the PCBs are listed in the Electrical Part List.
3.  This part is critical for safety purposes. Failure to use a substitute replacement with the same safety characteristics as the recommended replacement part might create shock, fire and/or other hazards.
4. This part is referenced for informational purposes only. It is not stocked as a repair part. Refer to the next higher assembly for a replacement part.

PACKAGING PART LIST

PackLite™ A1 Amplifier Assembly (see Figure 1)

Item Number	Description	Bose® Part Number	Vendor Part Number	Qty.	Note
1	Filler, Sheet, 295x168x6, A=B	291589	1450-8830+0	1	
2	Owners Manual	287546	4301-7207+0	1	
3	Sheet, Warranty / Welcome	287553	3050-3681	1	
4	Carry Bag, Nylon 280x150x70	287554	4201-1000+1	1	
5	PackLite Amplifier Assembly	REF	-	1	
6	Filler, Lower, 292x167x46	291588	1450-8840+1	1	
7	Power Cord, 120V (US/Canada)	263453	-	1	3 ⚠
	Power Cord, L=2.5M, 230V (Europe)	173352	7012-6980+0		
	Power Cord, 240V (Australia)	264357	-		
8	Filler, Upper, 292x167x81	291587	1450-8850+1	1	
9	Cable Assy, 1/4" to 1/4", TRS, Stereo Signal Input, L=500mm	287556	7012-7130+0	1	
10	Carton, Single, 4 Color Printed	287550	1480-8201+0	1	
11	Carton, Master, 527x304x264mm	-	1437-6401+0-2	-	
-	PE BAG, 8.5x14x0.05	-	1497-4412+0	1	
-	PE BAG 350x120x0.05 (MIC Cable)	-	1497-7762+0	1	
-	PE BAG 350x120x0.05 (AC Cord)	-	1497-7762+0	1	
-	PE BAG 250x140x0.05 (Manual)	-	1497-7772+0	1	
-	Sheet, Notice	-	3050-3701+0	1	

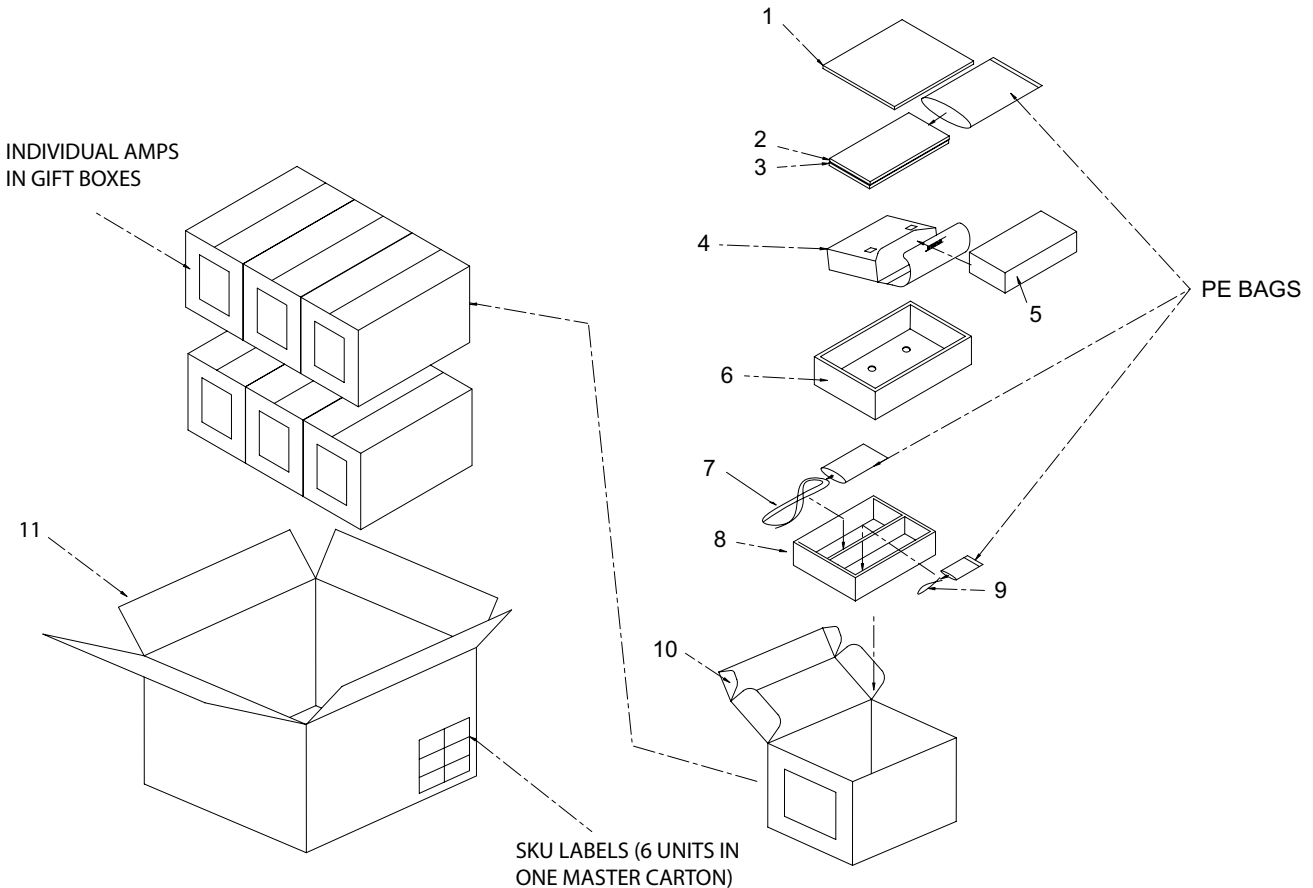









Figure 1. PackLite™ A1 Amplifier Assembly Packaging View

MAIN PART LIST

PackLite™ A1 Amplifier Assembly (see Figure 2)

Item Number	Description	Bose® Part Number	Vendor Part Number	Qty.	Note
1	Housing, Chassis, Upper, 266x140x28mm, Alum, Die-cast	-	1405-6801-0	1	4
2	LED PCB Assembly, Input Signal and Limiting (part of the input/limiter PCB)	-	-	1	2
3	Bose® Logo, Alum, 40x9.8x1.3mm	288677	2150-7132-0	1	
4	Front Grille, Perforated, 124x48x0.8mm, E.G. Steel	288675	1405-6901-0	1	
5	Fan, DC, 12V, 40x40x10mm, (includes connector assy)	350844-001	8913-0070+0	1	 3
6	Foot, Rubber, Molded, 54x26x12mm, BLK	288673	4157-0981-0	4	
7	Heat Transfer Pad, Mica Sheet, 103x43x0.2mm	291331	3100-6751	1	
8	SMPS/Amplifier PCB Assembly (120V Units only)	283302	SVC-BS90C11-AMP	1	2, 3
	SMPS/Amplifier PCB Assembly (230/240V Units only)	291337	SVC-BS90C21-AMP		
9	Input / Limiter PCB Assembly	287555	SVC-BS90C11-INP	1	2
10	Housing, Chassis, Lower, 266x140x28mm, Alum, Die-cast	-	1405-6601-0	1	4
11	Spring Washer	-	2607-3009-0550	4	
12	Screw, Chassis	-	2944-3012-3000	4	
13	Label, Safety, 120V Units Label, Safety, 230/240V Units	-	3001-0899+0 3001-0900+0	1	 3, 4
14	PC Sheet 1, Insulating	-	4155-1771+0	1	4
15	Conn, Neutrik Speakon, NL4MD-V, (For J 117, J118 & J119)	275446	2113-1336-1	1	 3
16	Switch, AC Power, SPST, TV5, 10A, 250V, 120V Units	291333	5200-4926	1	3
	Switch, AC Power, Rocker, SPST, 10A, 250V, TV-5, 230/240V Units	291335	5200-4926		
17	AC Input Jack, IEC	-	2113-3135+0	1	 3
18	I/O Panel, Rear, 123x48x1.2mm, BLK, SECC	288674	1405-7001-0	1	 3
19	LED PCB Assembly, Power and Fault (part of the input/limiter PCB)	-	1725-806A-0000	2	2
20	Lens, LED	-	3717-2506-0	2	
21	PC Sheet 2, Insulating	-	4155-1781+0	1	4
-	WIRE-CONN 4P P3.96 #18 UL1015 L=200 F (POWER AND FAULT LED PCB)	-	7012-7042+0	1	4
-	WIRE-CONN 3P P7.92/11.88 #18 UL1015 L=170 F (SIGNAL AND LIMITING LED PCB)	-	7012-7150+0	1	4

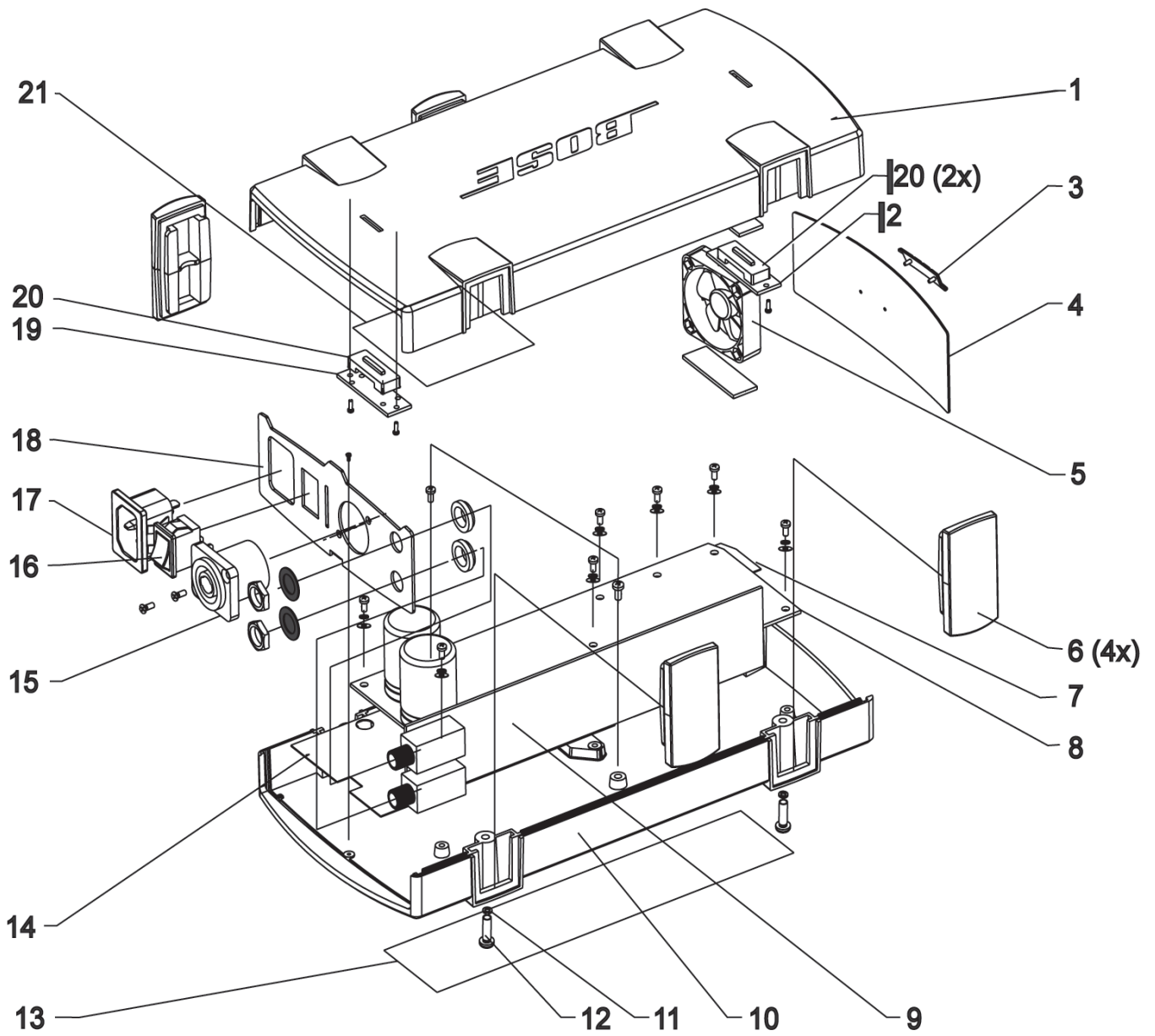



Figure 2. PackLite™ A1 Amplifier Exploded View

ELECTRICAL PART LIST

Power Supply / Amplifier PCB Assembly

Resistors

Reference Designator	Description	Vendor Part Number	Note
R1	1K, RMG, 0603/1608, 1/16W, 1%	4723-102A+P	4
R3	1K, RMG, 0603/1608, 1/16W, 1%	4723-102A+P	4
R4	10K, RMG, 0603/1608, 1/16W, 1%	4723-103A-P	4
R5	1K, RMG, 0603/1608, 1/16W, 1%	4723-102A+P	4
R6	4.7K, RMG, 0603/1608, 1/16W, 1%	4723-472A-P	4
R7	16K, RMG, 0805, 1/10W, 1%	4720-163A-J	4
R8	12K, RMG, 1206, 1/4W, 1%	4725-123A+6	4
R9	9.1K, RMG, 0805, 1/10W, 1%	4720-912A-J	4
R10	9.1K, RMG, 0805, 1/10W, 1%	4720-912A-J	4
R11	2.2 OHM, RMG, 0603/1608, 1/16W, 5%	4723-2R2J-P	4
R12	2.2 OHM, RMG, 0603/1608, 1/16W, 5%	4723-2R2J-P	4
R13	1M, RMG, 0603/1608, 1/16W, 5%	4723-105J-P	4
R14	1M, RMG, 0603/1608, 1/16W, 5%	4723-105J-P	4
R15	1.5K, RMG, 0603/1608, 1/16W, 1%	4723-152A-P	4
R16	0 OHM, RMG, 0805, 1/10W, 5%	4720-000J+J	4
R17	8.2K, RMG, 0603/1608, 1/16W, 5%	4723-822J+P	4
R18	6.8K, RMG, 0603/1608, 1/16W, 1%	4723-682A-P	4
R19	9.1K, RMG, 0805, 1/10W, 1%	4720-912A-J	4
R20	4.7 OHM, RWR, 5W, 5%, RL	474B-4R7J+5	3, 4 
R21	64.9K, RMG, 0603, 1/16W, 1%	4723-6492+P	4
R22	0 OHM, RMG, 0805, 1/10W, 5%	4720-000J+J	4
R23	9.1K, RMG, 0805, 1/10W, 1%	4720-912A-J	4
R24	3.3K, RMG, 0603/1608, 1/16W, 1%	4723-332A-P	4
R25	3.3K, RMG, 0603/1608, 1/16W, 1%	4723-332A-P	4
R26	64.9K, RMG, 0603, 1/16W, 1%	4723-6492+P	4
R27	4.7K, RMG, 0603/1608, 1/16W, 1%	4723-472A-P	4
R28	1K, RMG, 0603/1608, 1/16W, 1%	4723-102A+P	4
R29	12K, RMG, 1206, 1/4W, 1%	4725-123A+6	4
R30	16K, RMG, 0805, 1/10W, 1%	4720-163A-J	4
R31	1.5K, RMG, 0603/1608, 1/16W, 1%	4723-152A-P	4
R32	8.2K, RMG, 0603/1608, 1/16W, 5%	4723-822J+P	4
R34	10 OHM, RMG, 1206, 1/4W, 5%	4725-100J-6	4
R35	10 OHM, RMG, 1206, 1/4W, 5%	4725-100J-6	4
R36	0 OHM, RMG, 0603/1608, 1/16W, 5%	4723-000J-P	4
R38	10 OHM, RMG, 0805, 1/10W, 1%	4720-100A+J	4
R39	10 OHM, RMG, 0805, 1/10W, 1%	4720-100A+J	4
R41	4.7 OHM, RWR, 5W, 5%, RL	474B-4R7J+5	3, 4 
R44	10K, RMG, 0603/1608, 1/16W, 1%	4723-103A-P	4
R45	100 OHM, RMG, 0603, 1/16W, 1%	4723-101A+P	4
R46	100 OHM, RMG, 0603, 1/16W, 1%	4723-101A+P	4
R47	100 OHM, RMG, 0603, 1/16W, 1%	4723-101A+P	4
R48	100 OHM, RMG, 0603, 1/16W, 1%	4723-101A+P	4
R49	47K, RMG, 0603/1608, 1/16W, 1%	4723-473A-P	4

ELECTRICAL PART LIST

Power Supply / Amplifier PCB Assembly



Resistors (continued)

Reference Designator	Description	Vendor Part Number	Note
R50	47K, RMG, 0603/1608, 1/16W, 1%	4723-473A-P	4
R51	47K, RMG, 0603/1608, 1/16W, 1%	4723-473A-P	4
R52	1.8K, RMG, 0603/1608, 1/16W, 1%	4723-182A-P	4
R53	1K, RMG, 0603/1608, 1/16W, 1%	4723-102A+P	4
R54	1K, RMG, 0603/1608, 1/16W, 1%	4723-102A+P	4
R55	1K, RMG, 0603/1608, 1/16W, 1%	4723-102A+P	4
R56	1K, RMG, 0603/1608, 1/16W, 1%	4723-102A+P	4
R57	47K, RMG, 0603/1608, 1/16W, 1%	4723-473A-P	4
R58	2.2K, RMG, 0603/1608, 1/16W, 1%	4723-222A-P	4
R59	47K, RMG, 0603/1608, 1/16W, 1%	4723-473A-P	4
R60	1.8K, RMG, 0603/1608, 1/16W, 1%	4723-182A-P	4
R61	1K, RMG, 0603/1608, 1/16W, 1%	4723-102A+P	4
R62	1K, RMG, 0603/1608, 1/16W, 1%	4723-102A+P	4
R63	1K, RMG, 0603/1608, 1/16W, 1%	4723-102A+P	4
R64	1K, RMG, 0603/1608, 1/16W, 1%	4723-102A+P	4
R65	47K, RMG, 0603/1608, 1/16W, 1%	4723-473A-P	4
R66	2.2K, RMG, 0603/1608, 1/16W, 1%	4723-222A-P	4
R67	100 OHM, RMG, 0603, 1/16W, 1%	4723-101A+P	4
R68	560 OHM, RMG, 0603, 1/16W, 1%	4723-561A-P	4
R69	2.7K, RMG, 0603/1608, 1/16W, 1%	4723-272A+P	4
R70	2.7K, RMG, 0603/1608, 1/16W, 1%	4723-272A+P	4
R71	2.7K, RMG, 0603/1608, 1/16W, 1%	4723-272A+P	4
R72	2.7K, RMG, 0603/1608, 1/16W, 1%	4723-272A+P	4
R75	2.2 OHM, RMG, 0603/1608, 1/16W, 5%	4723-2R2J-P	4
R76	2.2 OHM, RMG, 0603/1608, 1/16W, 5%	4723-2R2J-P	4
R77	100 OHM, RMG, 0603, 1/16W, 1%	4723-101A+P	4
R78	100 OHM, RMG, 0603, 1/16W, 1%	4723-101A+P	4
R79	100 OHM, RMG, 0603, 1/16W, 1%	4723-101A+P	4
R80	100 OHM, RMG, 0603, 1/16W, 1%	4723-101A+P	4
R81	100 OHM, RMG, 0603, 1/16W, 1%	4723-101A+P	4
R83	100 OHM, RMG, 0603, 1/16W, 1%	4723-101A+P	4
R84	560 OHM, RMG, 0603, 1/16W, 1%	4723-561A-P	4
R85	560 OHM, RMG, 0603, 1/16W, 1%	4723-561A-P	4
R86	560 OHM, RMG, 0603, 1/16W, 1%	4723-561A-P	4
R87	100 OHM, RMG, 0603, 1/16W, 1%	4723-101A+P	4
R88	100 OHM, RMG, 0603, 1/16W, 1%	4723-101A+P	4
R89	100 OHM, RMG, 0603, 1/16W, 1%	4723-101A+P	4
R90	2.2 OHM, RMG, 0603/1608, 1/16W, 5%	4723-2R2J-P	4
R91	2.2 OHM, RMG, 0603/1608, 1/16W, 5%	4723-2R2J-P	4
R92	2.2K, RMG, 0603/1608, 1/16W, 1%	4723-222A-P	4
R93	2.2K, RMG, 0603/1608, 1/16W, 1%	4723-222A-P	4
R94	2.2K, RMG, 0603/1608, 1/16W, 1%	4723-222A-P	4
R95	2.2K, RMG, 0603/1608, 1/16W, 1%	4723-222A-P	4
R100	100K, RMG, 0805, 1/10W, 1%	4720-104A-J	4
R101	100K, RMG, 0805, 1/10W, 1%	4720-104A-J	4
R102	820K, RMG, 0805, 1/10W, 5%	4720-824J-J	4

ELECTRICAL PART LIST

Power Supply / Amplifier PCB Assembly

Resistors (continued)

Reference Designator	Description	Vendor Part Number	Note
R103	820K, RMG, 0805, 1/10W, 5%	4720-824J-J	4
R104	820K, RMG, 0805, 1/10W, 5%	4720-824J-J	4
R105	82K, RMG, 0805, 1/10W, 5%	4720-823J-J	4
R106	82K, RMG, 0805, 1/10W, 5%	4720-823J-J	4
R200	10K, RMG, 0603/1608, 1/16W, 1%	4723-103A-P	4
R202	1.5K, RMG, 0603/1608, 1/16W, 1%	4723-152A-P	4
R203	470 OHM, RMG, 0603/1608, 1/16W, 5%	4723-471J-P	4
R204	22 OHM, RMG, 0805, 1/10W, 5%	4720-220J-J	4
R205	22 OHM, RMG, 0805, 1/10W, 5%	4720-220J-J	4
R206	0.15 OHM, 1206, RMG, 1/4W, 5% (NON-ROHS UNITS)	4725-R15J+6	3, 4 
R206	0.12 OHM, RMG, 1206, 1/4W, 5% (ROHS COMPLIANT UNITS)	4725-R12J+6	3, 4 
R207	0.15 OHM, 1206, RMG, 1/4W, 5% (NON-ROHS UNITS)	4725-R15J+6	3, 4 
R207	0.12 OHM, RMG, 1206, 1/4W, 5% (ROHS COMPLIANT UNITS)	4725-R12J+6	3, 4 
R208	47K, RMG, 0805, 1/10W, 5%	4720-473J-J	4
R209	47K, RMG, 0805, 1/10W, 5%	4720-473J-J	4
R210	47K, RMG, 0805, 1/10W, 5%	4720-473J-J	4
R212	100 OHM, RMG, 0805, 1/10W, 5%	4720-101J-J	4
R213	0.15 OHM, 1206, RMG, 1/4W, 5% (NON-ROHS UNITS)	4725-R15J+6	3, 4 
R213	0.12 OHM, RMG, 1206, 1/4W, 5% (ROHS COMPLIANT UNITS)	4725-R12J+6	3, 4 
R214	0.15 OHM, 1206, RMG, 1/4W, 5% (NON-ROHS UNITS)	4725-R15J+6	3, 4 
R214	0.12 OHM, RMG, 1206, 1/4W, 5% (ROHS COMPLIANT UNITS)	4725-R12J+6	3, 4 
R215	47K, RMG, 0805, 1/10W, 5%	4720-473J-J	4
R217	470 OHM, RMG, 0603/1608, 1/16W, 5%	4723-471J-P	4
R218	10 OHM, RMG, 0805, 1/10W, 1%	4720-100J+J	4
R219	10 OHM, RMG, 0805, 1/10W, 1%	4720-100J+J	4
R222	1 OHM, RMG, 0603, 1/16W, 5%	4723-1R0J-P	4
R223	1 OHM, RMG, 0603, 1/16W, 5%	4723-1R0J-P	4
R230	10 OHM, RMG, 0805, 1/10W, 1%	4720-100A+J	4
R231	10 OHM, RMG, 0805, 1/10W, 1%	4720-100A+J	4
R232	36K, RMG, 0603, 1/16W, 1%	4723-363A+P	4

ELECTRICAL PART LIST

Power Supply / Amplifier PCB Assembly

Resistors (continued)

Reference Designator	Description	Vendor Part Number	Note
R233	36K, RMG, 0603, 1/16W, 1%	4723-363A+P	4
R234	10K, RMG, 0603/1608, 1/16W, 1%	4723-103A-P	4
R236	10K, RMG, 0603/1608, 1/16W, 1%	4723-103A-P	4
R238	36K, RMG, 0603, 1/16W, 1%	4723-363A+P	4
R239	36K, RMG, 0603, 1/16W, 1%	4723-363A+P	4
R240	47K, RMG, 0603/1608, 1/16W, 1%	4723-473A-P	4
R241	36K, RMG, 0603, 1/16W, 1%	4723-363A+P	4
R242	5.1K, RMG, 0603/1608, 1/16W, 1%	4723-512A+P	4
R243	5.1K, RMG, 0603/1608, 1/16W, 1%	4723-512A+P	4
R290	100K, RMG, 0603, 1/16W, 1%	4723-104A-P	4
R291	100 OHM, RMG, 0603, 1/16W, 1%	4723-101A+P	4
R300	10K, RMG, 1206, 1/8W, 5%	4721-103J+6	4

Capacitors

Reference Designator	Description	Vendor Part Number	Note
C1	1uF, CC, 0603, 10V, +80/-20%	150C-105Z-P-AC	4
C2	0.47uF, CC, 0805/2012, 16V, 10%, 1.5X2.5	150D-474K+J-BDL	4
C3	1uF, CC, 0603, 10V, +80/-20%	150C-105Z-P-AC	4
C4	1uF, CC, 0603, 10V, +80/-20%	150C-105Z-P-AC	4
C5	2700pF, CC, 0805, 50V, 10%, 1.2X2.0	150F-272K+J-BD	4
C6	47pF, CTC, 0603, 0/60, 5%, 0.8X1.6	15CH-470J-P-AC	4
C7	330pF, CTC, 0603, 0/60, 5%, 0.8X1.6	15CH-331J+P-AC	4
C8	0.22uF, CC, 0805, 16V 10%, 1.2X2.0	150D-224K+J-BD	4
C9	220pF, CTC, 1206, 0/30, 100V, 5%	15CG-221J+6-CFH	4
C10	3300pF, CC, 0805, 50V, 10%, 1.2x2.0	150F-332K-J-BD	4
C11	680pF, CTC, 0805, 0/30, 5%, 1.2x2.5	15CG-681J+J-BD	4
C12	1uF, CC, 0603, 10V, +80/-20%	150C-105Z-P-AC	4
C13	1uF, CC, 0603, 10V, +80/-20%	150C-105Z-P-AC	4
C14	4.7uF, CC, 1206, Y5V, 16V, +80/-20%	150D-475Z+6-CF	4
C15	0.47uF, CM, 100V, 10%, RB, 7.5X8	153H-474K+9-NO	4
C16	0.33uF, CM, 100V, 5%, RBT, 7.5X9.5, MKS2, WIMA	153H-334J+V-NRU	4
C17	3300pF, CC, 0805, 50V, 10%, 1.2x2.0	150F-332K-J-BD	4
C18	2700pF, CC, 0805, 50V, 10%, 1.2X2.0	150F-272K+J-BD	4
C19	680pF, CTC, 0805, 0/30, 5%, 1.2x2.5	15CG-681J+J-BD	4
C20	0.22uF, CC, 0805, 16V 10%, 1.2X2.0	150D-224K+J-BD	4
C21	4.7uF, CC, 1206, Y5V, 16V, +80/-20%	150D-475Z+6-CF	4
C22	0.47uF, CM, 100V, 10%, RB, 7.5X8	153H-474K+9-NO	4
C23	220pF, CTC, 1206, 0/30, 100V, 5%	15CG-221J+6-CFH	4
C24	0.33uF, CM, 100V, 5%, RBT, 7.5X9.5, MKS2, WIMA	153H-334J+V-NRU	4
C25	2200pF, CC, 0603, 50V, 10%, 0.8x1.6	150F-222K+P-AC	4
C26	2200pF, CC, 0603, 50V, 10%, 0.8x1.6	150F-222K+P-AC	4
C27	47pF, CTC, 0603, 0/60, 5%, 0.8X1.6	15CH-470J-P-AC	4
C28	330pF, CTC, 0603, 0/60, 5%, 0.8X1.6	15CH-331J+P-AC	4
C29	0.47uF, CC, 0805/2012, 16V, 10%, 1.5X2.5	150D-474K+J-BDL	4

ELECTRICAL PART LIST

Power Supply / Amplifier PCB Assembly







Capacitors (continued)

Reference Designator	Description	Vendor Part Number	Note
C31	2.2uF, CC, 1206, 50V, 10%, X7R, MURATA	150F-225K+6-CFM	4
C32	2.2uF, CC, 1206, 50V, 10%, X7R, MURATA	150F-225K+6-CFM	4
C33	1uF, 1206, X7R, CC, 50V, 10%, MURATA (NON-ROHS UNITS)	150F-105K+6-CFM	4
C33	2.2uF, CC, 1206, 50V, 10%, X7R, MURATA (ROHS COMPLIANT UNITS)	150F-225K+6-CFM	4
C34	1uF, 1206, X7R, CC, 50V, 10%, MURATA (NON-ROHS UNITS)	150F-105K+6-CFM	4
C34	2.2uF, CC, 1206, 50V, 10%, X7R, MURATA (ROHS COMPLIANT UNITS)	150F-225K+6-CFM	4
C35	0.01uF, CC, 0805, 50V, 20%, 1.2x2.0	150F-103M-J-BD	4
C36	0.01uF, CC, 0805, 50V, 20%, 1.2x2.0	150F-103M-J-BD	4
C37	2.2uF, CC, 1206, 50V, 10%, X7R, MURATA	150F-225K+6-CFM	4
C38	1uF, 1206, X7R, CC, 50V, 10%, MURATA (NON-ROHS UNITS)	150F-105K+6-CFM	4
C38	2.2uF, CC, 1206, 50V, 10%, X7R, MURATA (ROHS COMPLIANT UNITS)	150F-225K+6-CFM	4
C39	1uF, 1206, X7R, CC, 50V, 10%, MURATA (NON-ROHS UNITS)	150F-105K+6-CFM	4
C39	2.2uF, CC, 1206, 50V, 10%, X7R, MURATA (ROHS COMPLIANT UNITS)	150F-225K+6-CFM	4
C40	1uF, 1206, X7R, CC, 50V, 10%, MURATA (NON-ROHS UNITS)	150F-105K+6-CFM	4
C40	2.2uF, CC, 1206, 50V, 10%, X7R, MURATA (ROHS COMPLIANT UNITS)	150F-225K+6-CFM	4
C43	2200uF, 105C, CE, RL, 50V, 20%, 22X25 (NON-ROHS UNITS)	157F-228M+5-+&T	4
C43	2200uF, CE, 50V, 105C, 20%, RL, 18X31 (ROHS COMPLIANT UNITS)	157F-228M+5-7\$T	4
C44	2200uF, 105C, CE, RL, 50V, 20%, 22X25 (NON-ROHS UNITS)	157F-228M+5-+&T	4
C44	2200uF, CE, 50V, 105C, 20%, RL, 18X31 (ROHS COMPLIANT UNITS)	157F-228M+5-7\$T	4
C45	220pF, CTC, 0603, 0/60, 5%, 0.8X1.6	15CH-221J+P-AC	4
C46	1uF, CC, 0603, 10V, +80/-20%	150C-105Z-P-AC	4
C47	1uF, CC, 0603, 10V, +80/-20%	150C-105Z-P-AC	4
C48	2.2uF, CM, 50V, 5%, 10X8, METALLIZED	153F-225J+K-SOM	4
C49	2.2uF, CM, 50V, 5%, 10X8, METALLIZED	153F-225J+K-SOM	4
C51	1000pF, CTC, 0805, 0/30, 5%, 1.2x2.5	15CG-102J-J-BD	4
C52	1000pF, CTC, 0805, 0/30, 5%, 1.2x2.5	15CG-102J-J-BD	4
C53	1000pF, CTC, 0805, 0/30, 5%, 1.2x2.5	15CG-102J-J-BD	4
C54	1000pF, CTC, 0805, 0/30, 5%, 1.2x2.5	15CG-102J-J-BD	4
C56	1000pF, CTC, 0805, 0/30, 5%, 1.2x2.5	15CG-102J-J-BD	4
C57	1000pF, CTC, 0805, 0/30, 5%, 1.2x2.5	15CG-102J-J-BD	4
C58	1000pF, CTC, 0805, 0/30, 5%, 1.2x2.5	15CG-102J-J-BD	4
C59	1000pF, CTC, 0805, 0/30, 5%, 1.2x2.5	15CG-102J-J-BD	4

ELECTRICAL PART LIST

Power Supply / Amplifier PCB Assembly



Capacitors (continued)

Reference Designator	Description	Vendor Part Number	Note
C60	220pF, CTC, 0603, 0/60, 5%, 0.8X1.6	15CH-221J+P-AC	4
C61	220pF, CTC, 0603, 0/60, 5%, 0.8X1.6	15CH-221J+P-AC	4
C62	220pF, CTC, 0603, 0/60, 5%, 0.8X1.6	15CH-221J+P-AC	4
C63	1000pF, CTC, 0805, 0/30, 5%, 1.2x2.5	15CG-102J-J-BD	4
C68	0.1uF, CC, 0603/1608, 50V, 10%, 1x2	150F-104K-P-AC	4
C100	0.33uF, CM, 300V, 10%, RB, 18X15.5X10	1511-334K+9-03Z	3, 4 
C103	0.015uF, CC, 1206, X7R, 630V, 10%	150M-153K+6-CF	4
C104	0.015uF, CC, 1206, X7R, 630V, 10%	150M-153K+6-CF	4
C105	0.015uF, CC, 1206, X7R, 630V, 10%	150M-153K+6-CF	4
C106	0.015uF, CC, 1206, X7R, 630V, 10%	150M-153K+6-CF	4
C107	680uF, CE, 200V, 105C, 20%, RL, 25X35	157U-687M+5-&^T	4
C108	680uF, CE, 200V, 105C, 20%, RL, 25X35	157U-687M+5-&^T	4
C109	1000pF, CC, 400V, 20%, RL, 9X6	150T-102M+5-QK	3, 4 
C110	1000pF, CC, 400V, 20%, RL, 9X6	150T-102M+5-QK	3, 4 
C111	2200pF, CC, 400V, 20%, RL, 10X6	150T-222M+5-SK	3, 4 
C112	0.33uF, CM, 300V, 10%, RB, 18X15.5X10	1511-334K+9-03Z	3, 4 
C200	680pF, CTC, 0603, 0/60, 5%	15CH-681J+P-AC	4
C201	0.22uF, CC, 0805, 16V 10%, 1.2X2.0	150D-224K+J-BD	4
C202	0.47uF, CM, 400VDC, 5%, RB, 18X17.5X9	1511-474J+9-0T	4
C203	0.47uF, CM, 400VDC, 5%, RB, 18X17.5X9	1511-474J+9-0T	4
C204	1uF, CC, 0805, 25V, 10%	150E-105K+J-BD	4
C205	1uF, CC, 0805, 25V, 10%	150E-105K+J-BD	4
C206	1uF, 1206, X7R, CC, 50V, 10%, MURATA (NON-ROHS UNITS)	150F-105K+6-CFM	4
C206	2.2uF, CC, 1206, 50V, 10%, X7R, MURATA (ROHS COMPLIANT UNITS)	150F-225K+6-CFM	4
C207	1uF, 1206, X7R, CC, 50V, 10%, MURATA (NON-ROHS UNITS)	150F-105K+6-CFM	4
C207	2.2uF, CC, 1206, 50V, 10%, X7R, MURATA (ROHS COMPLIANT UNITS)	150F-225K+6-CFM	4
C208	1uF, CC, 1206, X7R, 50V, 10%, MURATA	150F-105K+6-CFM	4
C210	470pF, CC, 2211, 250VAC, 10%, 2.8X5.7	150R-471K+Y-EKZ	3, 4 
C211	1uF, CC, 1206, X7R, 50V, 10%, MURATA	150F-105K+6-CFM	4



ELECTRICAL PART LIST

Power Supply / Amplifier PCB Assembly

Capacitors (continued)

Reference Designator	Description	Vendor Part Number	Note
C212	470pF, CC, 2211, 250VAC, 10%, 2.8X5.7	150R-471K+Y-EKZ	3, 4 
C213	470pF, CC, 2211, 250VAC, 10%, 2.8X5.7	150R-471K+Y-EKZ	3, 4 
C214	100pF, CC, 0603/1608, 50V, 5%, 1X2	150F-101J-P-AC	4
C215	100pF, CC, 0603/1608, 50V, 5%, 1X2	150F-101J-P-AC	4
C216	1000pF, CTC, 0805, 0/30, 5%, 1.2x2.5	15CG-102J-J-BD	4
C217	1000pF, CTC, 0805, 0/30, 5%, 1.2x2.5	15CG-102J-J-BD	4
C218	470pF, CC, 2211, 250VAC, 10%, 2.8X5.7	150R-471K+Y-EKZ	3, 4 
C219	1uF, CC, 1206, X7R, 50V, 10%, MURATA	150F-105K+6-CFM	4
C220	1uF, CC, 0603, 10V, +80/-20%	150C-105Z-P-AC	4
C221	1uF, CC, 0603, 10V, +80/-20%	150C-105Z-P-AC	4
C222	470uF, CE, 35V, 105C, 20%, RL, 10X20	157Q-477M+5-S9T	4
C223	470uF, CE, 35V, 105C, 20%, RL, 10X20	157Q-477M+5-S9T	4
C226	0.15uF, CC, 0805, 50V, 10%	150F-154K+J-BD	4
C227	0.15uF, CC, 0805, 50V, 10%	150F-154K+J-BD	4
C300	0.01uF, CC, 1206, 50V, 10%, 1.6x3.2	150F-103K-6-CF	4



Inductors

Reference Designator	Description	Vendor Part Number	Note
L1	CHOKE, COIL, 10uH, 10%, 7A, T94-2	1806-3899+0	4
L3	CHOKE, COIL, 10uH, 10%, 7A, T94-2	1806-3899+0	4
L6	FERRITE BEAD INDUCTOR, BL01RN1A1F1J	1808-0680-0	4
L7	FERRITE BEAD INDUCTOR, BL01RN1A1F1J	1808-0680-0	4
L8	CHOKE, COMMON MODE, 2X16uH, 8A, FT50-43	1806-3913+0	4
L100	CHOKE, COMMON MODE, 3A, 2X15MH, TC-2510 (NON-ROHS UNITS)	1806-3901+1	3, 4 
L100	CHOKE, COMMON MODE, 2X10mH, 3A, TC-2510 (ROHS COMPLIANT UNITS)	1806-3934+0	3, 4 
L101	CHOKE, COMMON MODE, 2X10mH, 3A, TC-2510	1806-3934+0	3, 4 
L200	INDUCTOR, 10uH, 500MA, SMD, 1210	1803-0092+0	4
L201	INDUCTOR, 10uH, 500MA, SMD, 1210	1803-0092+0	4

ELECTRICAL PART LIST

Power Supply / Amplifier PCB Assembly

Diodes

Reference Designator	Description	Vendor Part Number	Note
D1	BAS321, 200V, 250MA, 50NS, SOD323	480S-3210+3	4
D2	BAS321, 200V, 250MA, 50NS, SOD323	480S-3210+3	4
D3	BAS321, 200V, 250MA, 50NS, SOD323	480S-3210+3	4
D4	BAS321, 200V, 250MA, 50NS, SOD323	480S-3210+3	4
D5	BAS321, 200V, 250MA, 50NS, SOD323	480S-3210+3	4
D6	BAS321, 200V, 250MA, 50NS, SOD323	480S-3210+3	4
D7	BAS321, 200V, 250MA, 50NS, SOD323	480S-3210+3	4
D8	BAS321, 200V, 250MA, 50NS, SOD323	480S-3210+3	4
D9	BAS321, 200V, 250MA, 50NS, SOD323	480S-3210+3	4
D10	BAS321, 200V, 250MA, 50NS, SOD323	480S-3210+3	4
D14	BAS321, 200V, 250MA, 50NS, SOD323	480S-3210+3	4
D100	BRIDGE, GBU8J, 600V, 8A, RL (NON-ROHS UNITS)	4840-9211+5	3, 4 
D100	DIODE BRIDGE, 800V, 8A, GBU8K, RL (ROHS COMPLIANT UNITS)	4840-9218+5	3, 4 
D200	US1J, 600V, 1A, 75NS, SOD124	480U-S1J0+3	4
D201	BAS216, 75V, 250MA, 4NS, SOD110	480S-2160+3	4
D202	BAS216, 75V, 250MA, 4NS, SOD110	480S-2160+3	4
D203	BAS216, 75V, 250MA, 4NS, SOD110	480S-2160+3	4
D204	BAS216, 75V, 250MA, 4NS, SOD110	480S-2160+3	4
D205	12CWQ10FNTRBF, RECTIFIER, 100V, 12A, DPAK, SMDIR	4840-9213+3	4
D206	12CWQ10FNTRBF, RECTIFIER, 100V, 12A, DPAK, SMDIR	4840-9213+3	4
D207	12CWQ10FNTRBF, RECTIFIER, 100V, 12A, DPAK, SMDIR	4840-9213+3	4
D208	12CWQ10FNTRBF, RECTIFIER, 100V, 12A, DPAK, SMDIR	4840-9213+3	4
D209	RS1D, RECTIFIER, 200V, 1A, SOD124	4840-9212+3	4
D210	RS1D, RECTIFIER, 200V, 1A, SOD124	4840-9212+3	4
D211	BAS216, 75V, 250MA, 4NS, SOD110	480S-2160+3	4
D212	BAS216, 75V, 250MA, 4NS, SOD110	480S-2160+3	4
D216	BAS216, 75V, 250MA, 4NS, SOD110	480S-2160+3	4
D217	BAS216, 75V, 250MA, 4NS, SOD110	480S-2160+3	4
D218	BAS216, 75V, 250MA, 4NS, SOD110	480S-2160+3	4
D290	BAS216, 75V, 250MA, 4NS, SOD110	480S-2160+3	4
Z200	ZENER, 15V, 0.4W, BZX284-B15	4840-9230+0	4
Z201	ZENER, BZX284-C11@115, 11V, 1/2W, DZ, SOD110	4837-1109+3	4

ELECTRICAL PART LIST

Power Supply / Amplifier PCB Assembly

Transistors

Reference Designator	Description	Vendor Part Number	Note
Q1	FDD368, MOSFET, N-CHANNEL, 2_NL, 100V, 32A, TO-252AA (Bose [®] part number 291330)	4903-6820+3	
Q2	FDD368, MOSFET, N-CHANNEL, 2_NL, 100V, 32A, TO-252AA (Bose part number 291330)	4903-6820+3	
Q3	FDD368, MOSFET, N-CHANNEL, 2_NL, 100V, 32A, TO-252AA (Bose part number 291330)	4903-6820+3	
Q4	FDD368, MOSFET, N-CHANNEL, 2_NL, 100V, 32A, TO-252AA (Bose part number 291330)	4903-6820+3	
Q5	BC856S, PNP PAIR, 60V, SOT363	4858-56S0+3	4
Q6	BC856S, PNP PAIR, 60V, SOT363	4858-56S0+3	4
Q200	STB12NM50FD, MOSFET, N-CHANNEL, D2PAK (Bose part number 291329)	4905-0FD0+3	
Q201	STB12NM50FD, MOSFET, N-CHANNEL, D2PAK (Bose part number 291329)	4905-0FD0+3	
Q202	REGULATOR, 5V, LM78L05ACM, SO-8	3131-3390+0	4
Q203	BCP56-10, NPN, SOT223	485C-P560+3	4
Q204	REGULATOR, 250MA, LM79L05, SO8	3132-3091+0	4
Q205	FFB2227A, NPN/PNP PAIR, SC70-6	4852-27A0+3	4
Q206	FFB2227A, NPN/PNP PAIR, SC70-6	4852-27A0+3	4
Q207	BC856S, PNP PAIR, 60V, SOT363	4858-56S0+3	4
Q208	2N7002MTF, MOSFET, N-CHANNEL, SOT-23	4902-MTF0-3	4
Q209	2N7002MTF, MOSFET, N-CHANNEL, SOT-23	4902-MTF0-3	4
Q210	BC856S, PNP PAIR, 60V, SOT363	4858-56S0+3	4
Q211	BC846B, SOT23, PHILIPS, SMD	4858-46B0+3	4
Q290	PUMZ1, NPN/PNP PAIR, SOT363	485U-MZ10+3	4











Integrated Circuits

Reference Designator	Description	Vendor Part Number	Note
IC1	HALF BRIDGE DRIVER, LV4970M, SO-16	3132-3051+0	4
IC2	HALF BRIDGE DRIVER, LV4970M, SO-16	3132-3051+0	4
IC3	ANALOG 2CH CONTROLLER, LV4930M, QUAD44	3132-3061+0	4
IC4	OP-AMP, MC33078DR2G, SO-8	3132-2711+0	4
IC200	HALF BRIDGE DRIVER, L6571BD013TR, SO8 (Bose part number 291328)	3132-3071+0	

ELECTRICAL PART LIST

Power Supply / Amplifier PCB Assembly

Miscellaneous

Reference Designator	Description	Vendor Part Number	Note
F100	FUSE, T6.3A/125V, TE5-T, PSE/UL (120V UNITS)	5120-1094+0	3, 4 
F100	FUSE, T3.15A, 250V, 8.5X8, VDE/UL/SEMKO, TR5-T (220-240V UNITS)	5120-0087+0	3, 4 
F200	0 OHM, RMG, 1206, 1/8W, 1%	4721-000A+6	3, 4 
MOV1	VARISTOR, 175V, SIOV-S05K175 (NON-ROHS UNITS)	4735-0002+0	3, 4 
MOV2	VARISTOR, 175V, SIOV-S05K175 (NON-ROHS UNITS)	4735-0002+0	3, 4 
MOV	VARISTOR, 320V, 10%, SIOV-S10K320 (ROHS COMPLIANT UNITS)	4735-0003+0	3, 4 
N1	THERMISTOR, NTC, 100K, 5,% B5, 7620C0104J162, 0805, EPCOS	5202-0019+0	4
N100	NTC THERMISTOR, 5 0HM, 4A, NIOSP005L, UL/CSA/VDE	5202-0010+0	3, 4 
N101	NTC THERMISTOR, 5 0HM, 4A, NIOSP005L, UL/CSA/VDE	5202-0010+0	3, 4 
N200	THERMISTOR, PTC, 1K, 0805, 90 DEG, EPCOS	5202-0011+0	4
N201	THERMISTOR, PTC, 1K, 130 DEG, 0805, EPCOS	5202-0021+0	4
S100	WJ, #23, 120/220-240V SELECTOR JUMPER. (USED ON 120V UNITS ONLY)	635N-0001-0	4
S302	WJ, #23	635N-0001-0	4
TRAFO200	TRANSFORMER, SWITCHING, ETD29	1806-3898+0	3, 4 
CON300	WAFER, 3P, P7.92/11.88, STRAIGHT	2101-3097+0	3, 4 
CON301	WAFER, 4P, P3.96 (NON-ROHS UNITS)	2101-3053-0	4
CON301	WAFER, 4P, P3.96 (ROHS COMPLIANT UNITS)	2101-3053+0	4
J301	6 PIN, WF	2102-060S+003	4
J302	6 PIN, WF	2102-060S+003	4
J303	WAFER, 3P, P2.0, ST, MALE	2101-3008+0	4
JP1	WIRE JUMPER, ROLLER FORM, D=0.6MM (ROHS COMPLIANT UNITS)	635N-0002+0	4
JP2	WIRE JUMPER, ROLLER FORM, D=0.6MM (ROHS COMPLIANT UNITS)	635N-0002+0	4

ELECTRICAL PART LIST

Input / Limiter PCB Assembly

Resistors

Reference Designator	Description	Vendor Part Number	Note
R301	39K, RMG, 0805, 1/10W, 1%	4720-393A+J	4
R302	39K, RMG, 0805, 1/10W, 1%	4720-393A+J	4
R303	24K, RMG, 0805, 1/10W, 5%	4720-243J+J	4
R304	100 OHM, RMG, 0805, 1/10W, 5%	4720-101J+J	4
R305	10K, RMG, 0805, 1/10W, 5%	4720-103J+J	4
R306	39K, RMG, 0805, 1/10W, 1%	4720-393A+J	4
R307	10K, RMG, 0805, 1/10W, 5%	4720-103J+J	4
R308	82K, RMG, 0805, 1/10W, 1%	4720-823A+J	4
R309	39K, RMG, 0805, 1/10W, 1%	4720-393A+J	4
R310	200K, RMG, 0805, 1/10W, 5%	4720-204J+J	4
R311	20K, RMG, 0805, 1/10W, 1%	4720-203A+J	4
R312	82K, RMG, 0805, 1/10W, 1%	4720-823A+J	4
R313	39K, RMG, 0805, 1/10W, 1%	4720-393A+J	4
R314	24K, RMG, 0805, 1/10W, 5%	4720-243J+J	4
R315	39K, RMG, 0805, 1/10W, 1%	4720-393A+J	4
R316	39K, RMG, 0805, 1/10W, 1%	4720-393A+J	4
R317	7.5K, RMG, 0805, 1/10W, 1%	4720-752A+J	4
R318	33K, RMG, 0805, 1/10W, 5%	4720-333J+J	4
R319	100K, RMG, 0805, 1/10W, 5%	4720-104J+J	4
R320	200K, RMG, 0805, 1/10W, 5%	4720-204J+J	4
R321	39K, RMG, 0805, 1/10W, 1%	4720-393A+J	4
R322	100 OHM, RMG, 0805, 1/10W, 5%	4720-101J+J	4
R323	22 OHM, RMG, 0805, 1/10W, 5%	4720-220J+J	4
R324	20K, RMG, 0805, 1/10W, 1%	4720-203J+J	4
R325	10K, RMG, 0805, 1/10W, 5%	4720-103J+J	4
R326	100K, RMG, 0805, 1/10W, 5%	4720-104J+J	4
R327	47K, RMG, 0805, 1/10W, 5%	4720-473J+J	4
R328	1K, RMG, 0805, 1/10W, 5%	4720-102J+J	4
R329	36K, RMG, 0805, 1/10W, 5%	4720-363J+J	4
R330	10K, RMG, 0805, 1/10W, 5%	4720-103J+J	4
R331	22 OHM, RMG, 0805, 1/10W, 5%	4720-220J+J	4
R333	750K, RMG, 0805, 1/10W, 5%	4720-754J+J	4
R334	510 OHM, RMG, 0805, 1/10W, 5%	4720-511J+J	4
R335	10K, RMG, 0805, 1/10W, 5%	4720-103J+J	4
R336	20K, RMG, 0805, 1/10W, 1%	4720-203J+J	4
R337	10K, RMG, 0805, 1/10W, 5%	4720-103J+J	4
R338	22K, RMG, 0805, 1/10W, 5%	4720-223J+J	4
R339	30K, RMG, 0805, 1/10W, 1%	4720-303J+J	4
R340	200K, RMG, 0805, 1/10W, 5%	4720-204J+J	4
R341	200K, RMG, 0805, 1/10W, 5%	4720-204J+J	4
R342	39K, RMG, 0805, 1/10W, 1%	4720-393A+J	4
R343	150K, RMG, 0805, 1/10W, 5%	4720-154J+J	4
R344	91K, RMG, 0805, 1/10W, 1%	4720-913A+J	4
R345	30K, RMG, 0805, 1/10W, 1%	4720-303J+J	4
R346	510 OHM, RMG, 0805, 1/10W, 5%	4720-511J+J	4
R347	39K, RMG, 0805, 1/10W, 1%	4720-393A+J	4

ELECTRICAL PART LIST

Input / Limiter PCB Assembly

Resistors (continued)

Reference Designator	Description	Vendor Part Number	Note
R348	2.7K, RMG, 0805, 1/10W, 1%	4720-272A+J	4
R349	750K, RMG, 0805, 1/10W, 5%	4720-754J+J	4
R350	30K, RMG, 0805, 1/10W, 1%	4720-303A+J	4
R351	0 OHM, RMG, 0805, 1/10W, 5%	4720-000J+J	4
R352	51 OHM, RCF, 1/4W, 5%, AT	4705-510J+2	4
R355	5.1K, RMG, 0805, 1/10W, 5%	4720-512J+J	4
R356	2.2K, RMG, 0805, 1/10W, 1%	4720-222J+J	4
R360	100 OHM, RMG, 0805, 1/10W, 5%	4720-101J+J	4
R361	49.9K, RMG, 0805, 1/10W, 1%	4720-4992+J	4
R362	510 OHM, RMG, 0805, 1/10W, 5%	4720-511J+J	4
R363	510 OHM, RMG, 0805, 1/10W, 5%	4720-511J+J	4
R364	1K, RMG, 0805, 1/10W, 5%	4720-102J+J	4
R365	10K, RMG, 0805, 1/10W, 5%	4720-103J+J	4
R366	150K, RMG, 0805, 1/10W, 5%	4720-154J+J	4
R367	51 OHM, RCF, 1/4W, 5%, AT	4705-510J+2	4
R368	39K, RMG, 0805, 1/10W, 1%	4720-393A+J	4
R369	12K, RMG, 0805, 1/10W, 1%	4720-123A+J	4
R370	2.2K, RMG, 0805, 1/10W, 1%	4720-222A+J	4
R377	510K, RMG, 0805, 1/10W, 5%	4720-514J+J	4
R378	2.2K, RMG, 0805, 1/10W, 1%	4720-222A+J	4
R379	39K, RMG, 0805, 1/10W, 1% (ROHS COMPLIANT UNITS)	4720-393A+J	4

Capacitors

Reference Designator	Description	Vendor Part Number	Note
C301	10uF, CE, 50V, 20%, RLT, 4X7	157F-106M+K-GM	4
C302	27pF, CTC, 0805, 0/30, 5%, 1.2X2.5	15CG-270J+J-BD	4
C303	10uF, CE, 50V, 20%, RLT, 4X7	157F-106M+K-GM	4
C304	100pF, CTC, 0805, 0/30, 5%, 1.2x2.5	15CG-101J+J-BD	4
C305	68pF, CC, 0805, 50V, 5%, 1.25X2.0, MURATA	150F-680J+J-BDM	4
C306	10uF, CE, 50V, 20%, RLT, 4X7	157F-106M+K-GM	4
C307	100pF, CTC, 0805, 0/30, 5%, 1.2x2.5	15CG-101J+J-BD	4
C308	100pF, CTC, 0805, 0/30, 5%, 1.2x2.5	15CG-101J+J-BD	4
C309	68pF, CC, 0805, 50V, 5%, 1.25X2.0, MURATA	150F-680J+J-BDM	4
C310	10uF, CE, 50V, 20%, RLT, 4X7	157F-106M+K-GM	4
C311	27pF, CTC, 0805, 0/30, 5%, 1.2X2.5	15CG-270J+J-BD	4
C312	10uF, CE, 50V, 20%, RLT, 4X7	157F-106M+K-GM	4
C313	47pF, CTC, 0805, 0/60, 5%, 1.2X2.5, 100V	15CH-470J+J-BD	4
C314	100pF, CTC, 0805, 0/30, 5%, 1.2x2.5	15CG-101J+J-BD	4
C315	20pF, 0805, CTC, 0/30, 5%, 1.2x2.5 (NON-ROHS UNITS)	15CG-200J-J-BD	4
C315	22pF, CTC, 0805, 0/60, 5%, 1.2X2.5 (ROHS COMPLIANT UNITS)	15CH-220J+J-BD	4
C316	100pF, CTC, 0805, 0/30, 5%, 1.2x2.5	15CG-101J+J-BD	4
C317	220pF, CC, 0805, 50V, 10%, 1.2x2.0	150F-221K+J-BD	4
C318	10uF, CE, 50V, 20%, RLT, 4X7	157F-106M+K-GM	4

ELECTRICAL PART LIST

Input / Limiter PCB Assembly

Capacitors (continued)

Reference Designator	Description	Vendor Part Number	Note
C319	1000pF, CTC, 0805, 0/30, 5%, 1.2x2.5	15CG-102J+J-BD	4
C320	1000pF, CTC, 0805, 0/30, 5%, 1.2x2.5	15CG-102J+J-BD	4
C321	1000pF, CTC, 0805, 0/30, 5%, 1.2x2.5	15CG-102J+J-BD	4
C322	1000pF, CTC, 0805, 0/30, 5%, 1.2x2.5	15CG-102J+J-BD	4
C323	1000pF, CTC, 0805, 0/30, 5%, 1.2x2.5	15CG-102J+J-BD	4
C324	1000pF, CTC, 0805, 0/30, 5%, 1.2x2.5	15CG-102J+J-BD	4
C328	10uF, CE, 50V, 20%, RLT, 4X7	157F-106M+K-GM	4
C329	1.0pF, CTC, 0805, 0/30, 50V, 1.2X2.5	15CG-1R0C+J-BDF	4
C330	100pF, CTC, 0805, 0/30, 5%, 1.2x2.5	15CG-101J+J-BD	4
C331	47uF, CE, 25V, 20%, RLT, 5X11, ELNA	157E-476M+K-IUE	4
C332	1000pF, CTC, 0805, 0/30, 5%, 1.2x2.5	15CG-102J+J-BD	4
C333	1000pF, CTC, 0805, 0/30, 5%, 1.2x2.5	15CG-102J+J-BD	4
C334	1000pF, CTC, 0805, 0/30, 5%, 1.2x2.5	15CG-102J+J-BD	4
C335	1000pF, CTC, 0805, 0/30, 5%, 1.2x2.5	15CG-102J+J-BD	4
C336	1000pF, CTC, 0805, 0/30, 5%, 1.2x2.5	15CG-102J+J-BD	4
C337	1000pF, CTC, 0805, 0/30, 5%, 1.2x2.5	15CG-102J+J-BD	4
C338	1000pF, CTC, 0805, 0/30, 5%, 1.2x2.5	15CG-102J+J-BD	4
C343	2.2uF, CE, 50V, 20%, RLT, 4X7, ELNA	157F-225M+K-GMK	4
C344	1uF, CC, 0805, 25V, 10%	150E-105K+J-BD	4
C345	1uF, CE, 50V, 20%, RLT, 4X7	157F-105M+K-GM	4
C346	47uF, CE, 25V, 20%, RLT, 5X11, ELNA	157E-476M+K-IUE	4
C347	47uF, CE, 25V, 20%, RLT, 5X11, ELNA	157E-476M+K-IUE	4
C350	10uF, CE, 50V, 20%, RLT, 4X7	157F-106M+K-GM	4
C352	0.1uF, CC, 0805, 50V, 20%, 1.2x2.0	150F-104M+J-BD	4
C353	22uF, CE, 25V, 20%, RLT, 5X11	157E-226M+K-IU	4
C354	0.1uF, CC, 0805, 50V, 20%, 1.2x2.0	150F-104M+J-BD	4
C355	22uF, CE, 25V, 20%, RLT, 5X11	157E-226M+K-IU	4
C356	10uF, CE, 50V, 20%, RLT, 4X7	157F-106M+K-GM	4
C357	0.1uF, CC, 0805, 50V, 20%, 1.2x2.0	150F-104M+J-BD	4
C358	10uF, CE, 50V, 20%, RLT, 4X7	157F-106M+K-GM	4
C359	0.1uF, CC, 0805, 50V, 20%, 1.2x2.0	150F-104M+J-BD	4
C360	100pF, CTC, 0805, 0/30, 5%, 1.2x2.5	15CG-101J+J-BD	4
C361	10uF, CE, 50V, 20%, RLT, 4X7	157F-106M+K-GM	4
C362	0.47uF, CC, 0805, 25V, 20%	150E-474M+J-BD	4
C363	47uF, CE, 25V, 20%, RLT, 5X11, ELNA	157E-476M+K-IUE	4
C364	1000pF, 50V, 0805, CC, 10%, 1.2x2.0 (NON-ROHS UNITS)	150F-102K-J-BD	4
C365	1000pF, 50V, 0805, CC, 10%, 1.2x2.0 (NON-ROHS UNITS)	150F-102K-J-BD	4
C366	1000pF, 50V, 0805, CC, 10%, 1.2x2.0 (NON-ROHS UNITS)	150F-102K-J-BD	4
C367	1000pF, 50V, 0805, CC, 10%, 1.2x2.0 (NON-ROHS UNITS)	150F-102K-J-BD	4
C368	220uF, CE, 16V, 20%, RLT, 6.3X11, SC, SHOEI	157D-227M+K-LUI	4
C369	2.2uF, CE, 50V, 20%, RLT, 4X7, ELNA	157F-225M+K-	4

ELECTRICAL PART LIST

Input / Limiter PCB Assembly

Diodes

Reference Designator	Description	Vendor Part Number	Note
D301	1N4148T, AT	4804-1480+2	4
D302	1N4148T, AT	4804-1480+2	4
D303	1N4148T, AT	4804-1480+2	4
D304	1N4148T, AT	4804-1480+2	4
D305	1N4148, AT (NON-ROHS UNITS)	4804-1480-2	4
D305	ZENER, 12V, 1/2W, 5%, AT, TEMIC (ROHS COMPLIANT UNITS)	4837-1206+2	4
D306	1N4148, AT (NON-ROHS UNITS)	4804-1480-2	4
D306	ZENER, 12V, 1/2W, 5%, AT, TEMIC (ROHS COMPLIANT UNITS)	4837-1206+2	4
D307	ZENER, 5.1V, 1/2W, AT, TEMIC	4837-5V16+2	4
D308	SCHOTTKY, BAT42-T, DO-35, AT	480A-T420+2	4
D309	1N4148T, AT	4804-1480+2	4
D310	ZENER, 12V, 1/2W, 5%, AT, TEMIC	4837-1206+2	4
D319	ZENER, 3V, 1/2W, 5%, MMSZ4683T1, SOD-123	4837-3V09+3	4
D320	ZENER, 3V, 1/2W, 5%, MMSZ4683T1, SOD-123	4837-3V09+3	4

Transistors

Reference Designator	Description	Vendor Part Number	Note
Q301	2N3904, RLT (NON-ROHS UNITS)	4853-9040-K	4
Q301	2N3904TA, RLT (ROHS COMPLIANT UNITS)	4853-9040+K	4
Q302	2N3904, RLT (NON-ROHS UNITS)	4853-9040-K	4
Q302	2N3904TA, RLT (ROHS COMPLIANT UNITS)	4853-9040+K	4
Q303	2N3904, RLT (NON-ROHS UNITS)	4853-9040-K	4
Q303	2N3904TA, RLT (ROHS COMPLIANT UNITS)	4853-9040+K	4
Q304	2N3906, RLT, TO92, PHILIPS (NON-ROHS UNITS)	4860-2390-K	4
Q304	2N3906, RLT, TO92, PHILIPS (ROHS COMPLIANT UNITS)	4860-2390+K	4
Q305	2N3904, RLT (NON-ROHS UNITS)	4853-9040-K	4
Q305	2N3904TA, RLT (ROHS COMPLIANT UNITS)	4853-9040+K	4
Q306	2N3904, RLT (NON-ROHS UNITS)	4853-9040-K	4
Q306	2N3904TA, RLT (ROHS COMPLIANT UNITS)	4853-9040+K	4
Q307	2N3904, RLT (NON-ROHS UNITS)	4853-9040-K	4
Q307	2N3904TA, RLT (ROHS COMPLIANT UNITS)	4853-9040+K	4
Q308	2N3906, RLT, TO92, PHILIPS (NON-ROHS UNITS)	4860-2390-K	4
Q308	2N3906, RLT, TO92, PHILIPS (ROHS COMPLIANT UNITS)	4860-2390+K	4
Q309	2N3904, RLT (NON-ROHS UNITS)	4853-9040-K	4
Q309	2N3904TA, RLT (ROHS COMPLIANT UNITS)	4853-9040+K	4
Q310	2N3906, RLT, TO92, PHILIPS (NON-ROHS UNITS)	4860-2390-K	4
Q310	2N3906, RLT, TO92, PHILIPS (ROHS COMPLIANT UNITS)	4860-2390-K	4

ELECTRICAL PART LIST

Input / Limiter PCB Assembly

Transistors (continued)

Reference Designator	Description	Vendor Part Number	Note
Q311	2N3904, RLT (NON-ROHS UNITS)	4853-9040-K	4
Q311	2N3904TA, RLT (ROHS COMPLIANT UNITS)	4853-9040+K	4
Q312	2N3904, RLT (NON-ROHS UNITS)	4853-9040-K	4
Q312	2N3904TA, RLT (ROHS COMPLIANT UNITS)	4853-9040+K	4
Q313	2N3904, RLT (NON-ROHS UNITS)	4853-9040-K	4
Q313	2N3904TA, RLT (ROHS COMPLIANT UNITS)	4853-9040+K	4

Integrated Circuits

Reference Designator	Description	Vendor Part Number	Note
U301	OP-AMP, NJM2068M, JRC (NON-ROHS UNITS)	3130-6890-0	4
U301	NJM2068M-#ZZZB, DUAL OP AMP (ROHS COMPLIANT UNITS)	3130-6890+0	4
U302	OP-AMP, NJM2068M, JRC (NON-ROHS UNITS)	3130-6890-0	4
U302	NJM2068M-#ZZZB, DUAL OP AMP (ROHS COMPLIANT UNITS)	3130-6890+0	4
U303	OP-AMP, NJM2068M, JRC (NON-ROHS UNITS)	3130-6890-0	4
U303	NJM2068M-#ZZZB, DUAL OP AMP (ROHS COMPLIANT UNITS)	3130-6890+0	4
U304	LM311M, VOLTAGE COMPARATOR	3130-9240+0	4
U305	LM13700M, TRANSCONDUCTANCE AMP	3132-1981+0	4
U306	OP-AMP, NJM2068M, JRC (NON-ROHS UNITS)	3130-6890-0	4
U306	NJM2068M-#ZZZB, DUAL OP AMP (ROHS COMPLIANT UNITS)	3130-6890+0	4
U310	L7815CV, REGULATOR, ST	3130-3030+0	4
U311	REGULATOR, -15V, 0.1A, 79L15, TO-92	3132-3041+0	4

Miscellaneous

Reference Designator	Description	Vendor Part Number	Note
N300	THERMISTOR, NTC, 22K, 5%, NCP21XW223J03, 0805, MURATA	5202-0022+0	3, 4 
J1	PHONE JACK, ST, 6.35MM	2113-1955+0	4
J2	PHONE JACK, ST, 6.35MM	2113-1955+0	4
CN101	WIRE-CONN, 6P, P2.0, #26, UL1007, L=150, F/M	7012-7063+0	4
CN102	WIRE-CONN, 6P, P2.0, #26, UL1007, L=150, F/M	7012-7063+0	4
CN103	WIRE-CONN, 3P, P2.0, #26, UL1007, L=50, F/M	7012-7061+0	4
CN104	WIRE-CONN, 4P, P2.0, #26, UL1007, L=160, F/M	7012-7062+0	4
CN105	WIRE-CONN, 3P, P2.0, #26, UL1007, L=120, F/M	7012-7061+1	4
CN106	WAFER, 2P, P2.0, RA, MALE	2101-3012+0	4
JP1	WIRE JUMPER, ROLLER FORM, D=0.6MM (ROHS COMPLIANT UNITS)	635N-0002+0	4

ELECTRICAL PART LIST

Input / Limiter PCB Assembly

Miscellaneous (continued)

Reference Designator	Description	Vendor Part Number	Note
JP2	WIRE JUMPER, ROLLER FORM, D=0.6MM	635N-0002+0	4
JP3	WIRE JUMPER, ROLLER FORM, D=0.6MM	635N-0002+0	4
JP4	WIRE JUMPER, ROLLER FORM, D=0.6MM	635N-0002+0	4
JP5	WIRE JUMPER, ROLLER FORM, D=0.6MM	635N-0002+0	4
JP6	WIRE JUMPER, ROLLER FORM, D=0.6MM	635N-0002+0	4
JP7	WIRE JUMPER, ROLLER FORM, D=0.6MM	635N-0002+0	4
JP8	WIRE JUMPER, ROLLER FORM, D=0.6MM	635N-0002+0	4
JP9	WIRE JUMPER, ROLLER FORM, D=0.6MM	635N-0002+0	4
JP10	WIRE JUMPER, ROLLER FORM, D=0.6MM	635N-0002+0	4
JP11	WIRE JUMPER, ROLLER FORM, D=0.6MM	635N-0002+0	4
JP12	WIRE JUMPER, ROLLER FORM, D=0.6MM	635N-0002+0	4
JP13	WIRE JUMPER, ROLLER FORM, D=0.6MM	635N-0002+0	4
JP14	WIRE JUMPER, ROLLER FORM, D=0.6MM	635N-0002+0	4
JP15	WIRE JUMPER, ROLLER FORM, D=0.6MM	635N-0002+0	4
JP16	WIRE JUMPER, ROLLER FORM, D=0.6MM	635N-0002+0	4
JP17	WIRE JUMPER, ROLLER FORM, D=0.6MM	635N-0002+0	4
JP18	WIRE JUMPER, ROLLER FORM, D=0.6MM	635N-0002+0	4
JP19	WIRE JUMPER, ROLLER FORM, D=0.6MM	635N-0002+0	4
JP20	WIRE JUMPER, ROLLER FORM, D=0.6MM	635N-0002+0	4
JP21	WIRE JUMPER, ROLLER FORM, D=0.6MM	635N-0002+0	4
JP22	WIRE JUMPER, ROLLER FORM, D=0.6MM	635N-0002+0	4
JP23	WIRE JUMPER, ROLLER FORM, D=0.6MM	635N-0002+0	4
JP24	WIRE JUMPER, ROLLER FORM, D=0.6MM	635N-0002+0	4
JP25	WIRE JUMPER, ROLLER FORM, D=0.6MM	635N-0002+0	4
JP26	WIRE JUMPER, ROLLER FORM, D=0.6MM	635N-0002+0	4
JP28	WIRE JUMPER, ROLLER FORM, D=0.6MM	635N-0002+0	4
JP29	WIRE JUMPER, ROLLER FORM, D=0.6MM	635N-0002+0	4
JP30	WIRE JUMPER, ROLLER FORM, D=0.6MM	635N-0002+0	4
JP31	WIRE JUMPER, ROLLER FORM, D=0.6MM	635N-0002+0	4
JP32	WIRE JUMPER, ROLLER FORM, D=0.6MM	635N-0002+0	4
JP34	WIRE JUMPER, ROLLER FORM, D=0.6MM	635N-0002+0	4
JP35	WIRE JUMPER, ROLLER FORM, D=0.6MM	635N-0002+0	4
JP36	WIRE JUMPER, ROLLER FORM, D=0.6MM	635N-0002+0	4
JP37	WIRE JUMPER, ROLLER FORM, D=0.6MM	635N-0002+0	4

ELECTRICAL PART LIST

Signal LED PCB Assembly

Diodes

Reference Designator	Description	Vendor Part Number	Note
D315	LOW CURRENT LED, SMD, RED, 2mA,	3700-7829+R	4
D316	LOW CURRENT LED, SMD, RED, 2mA,	3700-7829+R	4
D317	LED, OS, GN, LOW CURRENT, 525NM, 0603	3700-7834+G	4
D318	LED, OS, GN, LOW CURRENT, 525NM, 0603	3700-7834+G	4

Miscellaneous

Reference Designator	Description	Vendor Part Number	Note
CN205	CONN, 3 PIN, P2.0, ST, 25056457, 2002P0300T (NON-ROHS UNITS)	2101-3008-0	4
CN205	PLUG NPLG-3P350 25055367 (ROHS COMPLIANT UNITS)	2101-1516+0	4

Power / Fault LED PCB Assembly

Diodes

Reference Designator	Description	Vendor Part Number	Note
D311	LOW CURRENT SMD LED, RED, 2mA	3700-7829+R	4
D312	LOW CURRENT SMD LED, RED, 2mA	3700-7829+R	4
D313	LOW CURRENT SMD LED, BLUE	3700-7830+B	4
D314	LOW CURRENT SMD LED, BLUE	3700-7830+B	4

Miscellaneous

Reference Designator	Description	Vendor Part Number	Note
CN204	WAFER, 4P, P2.0, STRAIGHT	2102-040S+003	4

DISASSEMBLY PROCEDURES

The PackLite™ A1 amplifier is housed in a die-cast metal chassis. It is held together in a clam-shell type configuration using four screws.

Note: Refer to the photos at right or Figure 2 for the following information.

1. Top Chassis Housing Removal

1.1 Place the unit, top cover down, onto a soft surface.

1.2 Using a Phillips-head screwdriver, remove the four screws (12) that hold the upper (1) and lower (10) chassis housings together.

1.3 Turn the unit back over and carefully lift the top chassis housing straight up.

Re-assembly Note: When re-installing the top chassis housing, be sure that all four rubber feet (6) are aligned with the grooves in the upper chassis housing.

2. Input / Limiter PCB Assembly Removal

2.1 Perform procedure 1.

2.2 Using a pair of diagonal cutters, cut the three wire ties that secure the various wire harnesses to the input / limiter PCB (9).

2.3 Unplug the input / limiter PCB wiring harnesses from the power supply / amplifier PCB (8) at J301, J302 and J303.

2.4 Unplug the wiring harnesses at the two LED PCBs (2 & 19) that are mounted in the top housing.

2.5 Unplug the fan (5) wiring harness at CN106.

2.6 Using a 1/2" nut driver, remove the nuts that secure the INPUT and THRU 1/4" TRS jacks to the rear panel.

2.7 Lift up the back corner of the input / limiter PCB assembly and slide it away from the rear panel. Lift out the PCB assembly.

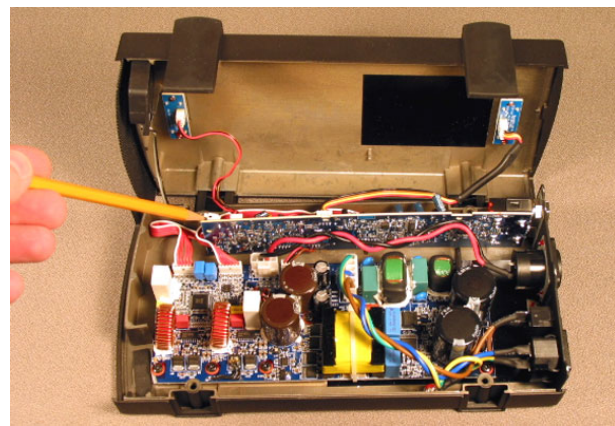
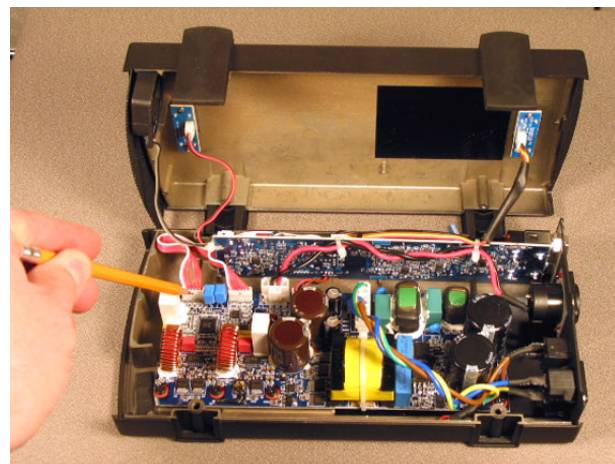

DISASSEMBLY PROCEDURES

3. Power Supply / Amplifier PCB Assembly Removal

3.1 Perform procedure 1.

3.2 Unplug the input / limiter PCB (9) wiring harnesses from the power supply / amplifier PCB (8) at J301, J302 and J303.

3.3 Unplug the wiring harnesses at CON300 and CON301 on the power supply / amplifier PCB assembly.

3.4 Using a Phillips-head screwdriver, remove the eight screws that secure the power supply / amplifier PCB assembly to the lower housing (10). Lift the PCB assembly out of the lower housing.

Re-assembly Notes:

1. Be sure to retain the washers and lock washers located under seven of the screws for use during re-assembly.
2. The silver colored screw located near C223 is used for grounding the PCB assembly to the lower housing. Be sure to use only the silver colored star washer under it to ensure a good ground connection.
3. Note the location of the thermal sil-pad (7) under the power supply / amplifier PCB assembly. Be sure it is in the proper location when re-installing the PCB assembly. See the photo at right.

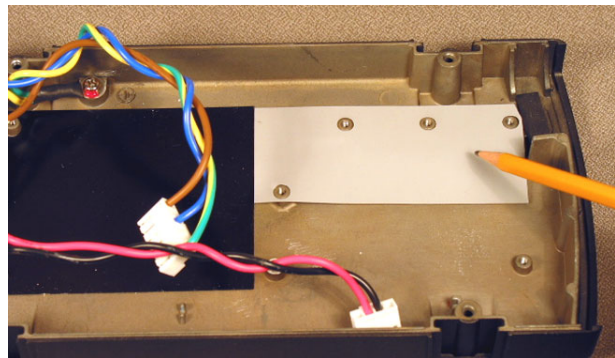
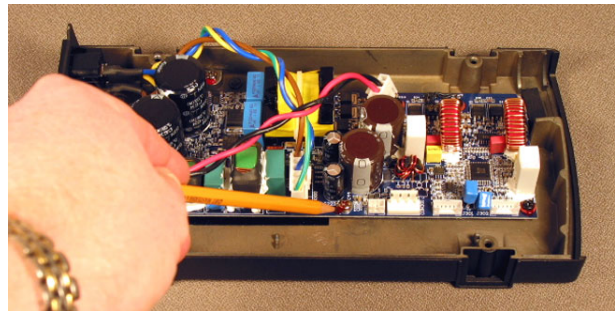
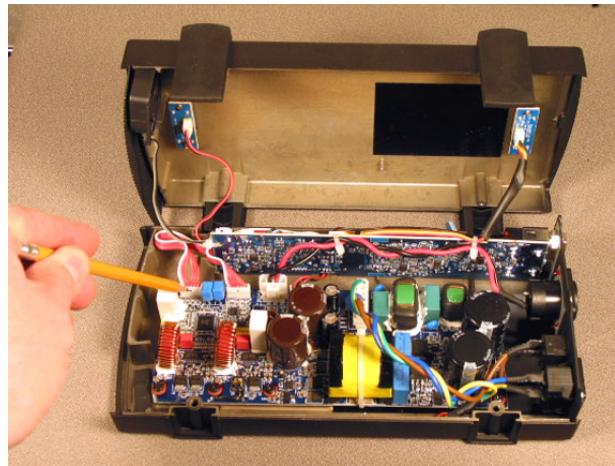

4. Fan Removal

4.1 Perform procedure 1.

4.2 Unplug the fan assembly (5) wiring harness at CN106 on the input / limiter PCB assembly (9).

4.3 Lift the fan assembly out of the upper housing.

Re-assembly Note: Be sure to note the orientation of the fan when removing it from the housing. It will need to be replaced facing the same direction to ensure that the outside air is pulled into the amplifier during operation.



DISASSEMBLY PROCEDURES

5. LED PCB Removal

5.1 Perform procedure 1.

5.2 Unplug the wiring harness from the input / limiter PCB (9) for the LED PCB (2 or 19) that you wish to remove. These harnesses unplug from the connector at the LED PCB end of the harness.

5.3 Using a small Phillips-head screwdriver, remove the two screws that secure the LED PCB to the upper housing. Lift the PCB off of the LED lens (20).

Re-assembly Notes:

1. Be sure to align the light pipe with the upper housing and to align the LED PCB with the four tabs on the LED lens.
2. Make a note of the direction that the LED PCB mounts to the upper housing. If you re-install it backward, the LED harness will interfere with the power supply caps during re-assembly.

6. Rear Panel Removal

6.1 Perform procedure 1.

6.2 Unplug the AC wiring harness from the power supply / amplifier PCB (8) at CON300.

6.3 Using a Phillips-head screwdriver, remove the screw that secures the AC wiring harness ground lug to the lower chassis housing. Retain the screw and washer for re-use.

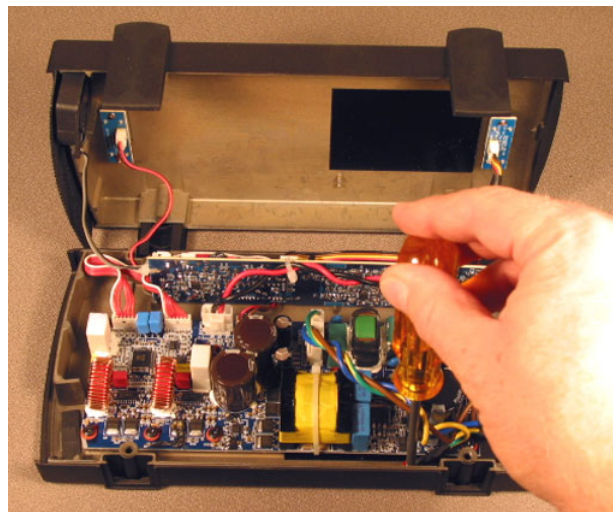
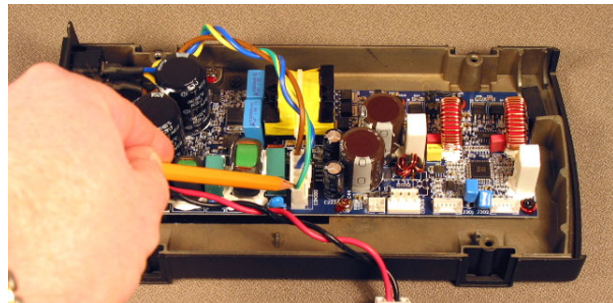
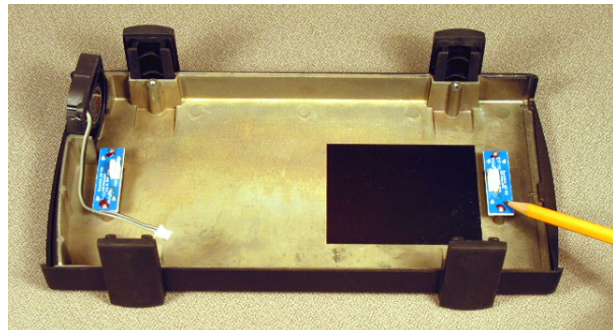
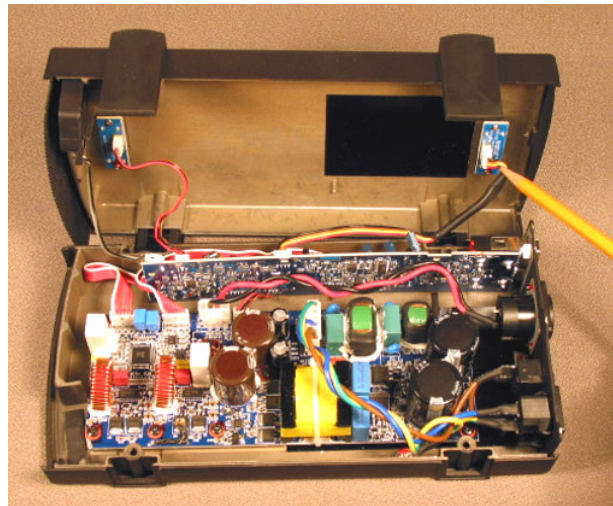

DISASSEMBLY PROCEDURES

6.4 Unplug the audio output wiring harness from the power supply / amplifier PCB (8) at CON301.

6.5. Using a small Phillips-head screwdriver, remove the one screw that secures the rear panel (18) to the lower chassis housing (10). Lift out the rear panel.

7. Front Panel Removal

7.1 Perform procedure 1.

7.2 Lift out the front panel (4).

Re-assembly Note: Be sure to align the front panel so that the Bose® logo is facing the correct direction.

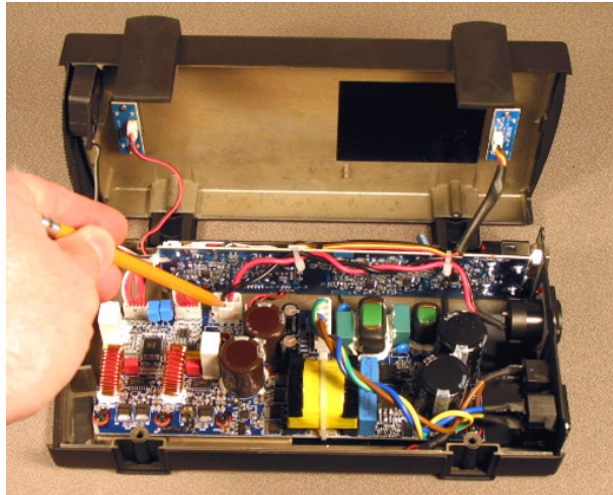

Test Procedures

Required Equipment:

- dB meter
- Audio Signal Generator w/balanced output
- Distortion meter
- 4 Ohm, 250 Watt load resistor
- Digital Multimeter
- 4 Ohm full range speaker
- 1/4" TRS 600 Ohm test plug (see page 41)
- 1/4" TRS balanced input cable
- 1/4" TS unbalanced input cable
- Amplifier output test cable (see page 41)

Test Setup Notes:

1. Make measurements on the output using an 80 kHz Low Pass Filter.
2. Remove the input signal after tests with high levels to avoid overheating the amplifier and load.
3. There are 120V and 220-240V versions of this product. The voltage version is indicated on the amplifier's product label.

1. DC Offset Test

1.1 Connect the output of the A1 to the 4 Ohm load.

1.2 Power on the unit, with no input signal present.

1.3 Measure the DC voltage across the load. It should be less than +/- 30 mV.

2. Gain and Signal LED Balanced Input Test

2.1 Connect the signal generator to either of the A1 input jacks with a balanced, 1/4" TRS cable.

2.2 Connect the output of the A1 to the 4 Ohm load.

2.3 Power on the unit

2.4 Apply a 1 kHz, -10 dBV (Tip to Ring) signal to the input.

2.5 Reference a dB meter (80 kHz LPF) to the input level. Measure the gain output at the load. It should be +24.0 ±4.0 dB.

3. Gain and Signal LED Unbalanced Input Test

3.1 Connect the signal generator to either of the A1 input jacks with an unbalanced, 1/4" Tip-Sleeve (TS) cable

TEST PROCEDURES

3.2 Connect the output of the A1 to the 4 Ohm load resistor.

3.3 Power on the unit.

3.4 Apply a 1 kHz, -10 dBV (T to S) signal to the input.

3.5 Reference a dB meter to the input level. Measure the gain output at the load. It should be $+30.0 \pm 4.0$ dB.

4. Signal LED Test

4.1 Confirm that the green signal LED is on.

4.2 Lower the input signal to less than -25 dBV. Confirm that the green LED turns off.

4.3 Raise the input signal to over 1 dBV. The LED should turn red.

Caution: Remove the input signal after this test to avoid overheating the amplifier and load.

5. Frequency Response & Distortion

5.1 Connect the signal generator to either of the A1 input jacks with an unbalanced, 1/4" TS cable.

5.2 Connect the output of the A1 to the 4 Ohm load resistor.

5.3 Power on the unit.

5.4 Apply a 1 kHz, -10 dBV (T to S) signal to the input.

5.5 Reference a dB meter to the input level. Measure the frequency response at the load. It should be $0.0 \text{ dB} \pm 1.0 \text{ dB}$ from 20 Hz to 20 kHz.

5.6 Measure the Total Harmonic Distortion (THD) at the load. It should be less than 0.1% (0.02% typical) at 1 kHz.

6. Signal to Noise Test

6.1 Remove the signal generator and insert a TRS test plug with a 600 Ohm termination between tip and ring. See page 37.

6.2 Measure the output voltage across the load resistor. It should read less than -60 dB A-weighted, (referenced to 1 Volt).

7. Power / Fault LED Test

7.1 Connect the output of the A1 to the 4 Ohm load resistor.

7.2 Power on the unit.

7.3 Confirm that the blue LED comes on.

7.4 Apply a 1 kHz, -10 dBV (T to R) signal to the input.

7.5 Short the loudspeaker output jack (plus + to minus -).

7.6 Confirm that the blue power LED changes to red. It will briefly change back to blue every second or so as long as the short is maintained.

7.7 Remove the short and power down the unit.

8. Listening Test

8.1 Connect a line-level audio source (such as a CD player) to the input jack.

8.2 Connect the output to a 4 Ohm full-range speaker.

8.3 The audio output should sound clean and undistorted.

8.4 Raise the input level until the green signal LED turns red occasionally. The audio output should still sound clean, although some limiting may be heard.

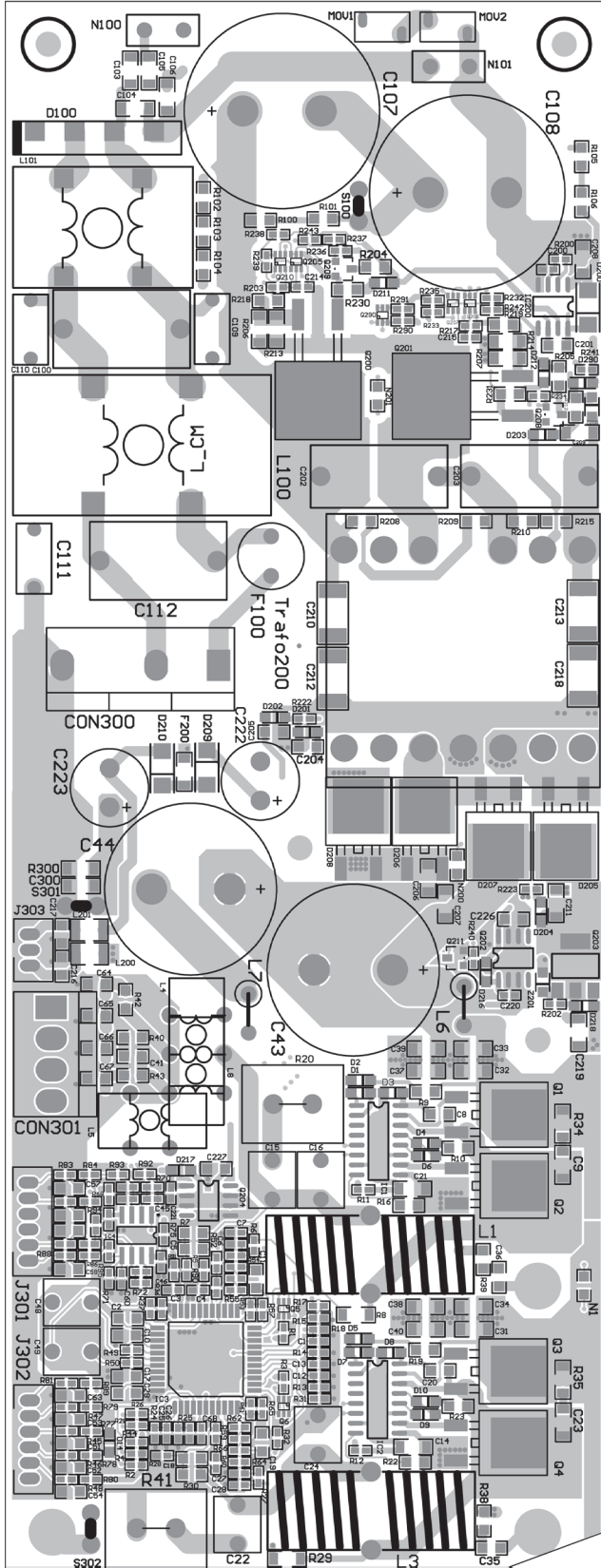

Figure 3. Amplifier/SMPS PCB (Non-RoHS)
Topside Etch Layout

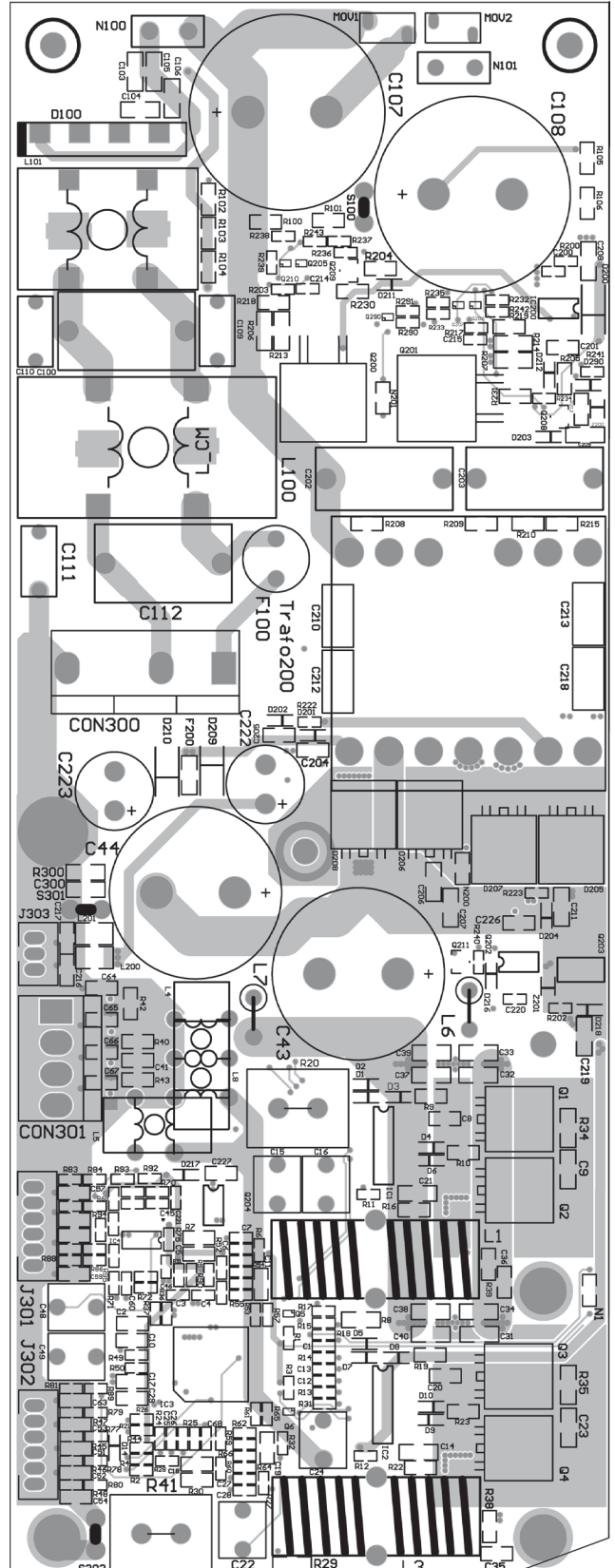

Figure 4. Amplifier/SMPS PCB (Non-RoHS)
Internal Etch Layer 1 Layout



Figure 11. Input/Limiter PCB (Non-RoHS) Top Side Etch Layout

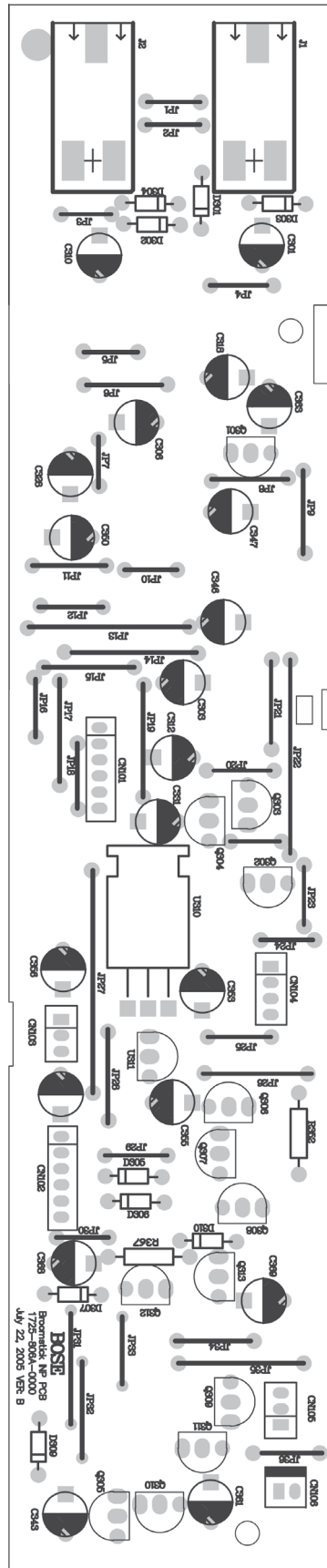

Figure 12. Input/Limiter PCB (Non-RoHS) Bottom Side Etch Layout

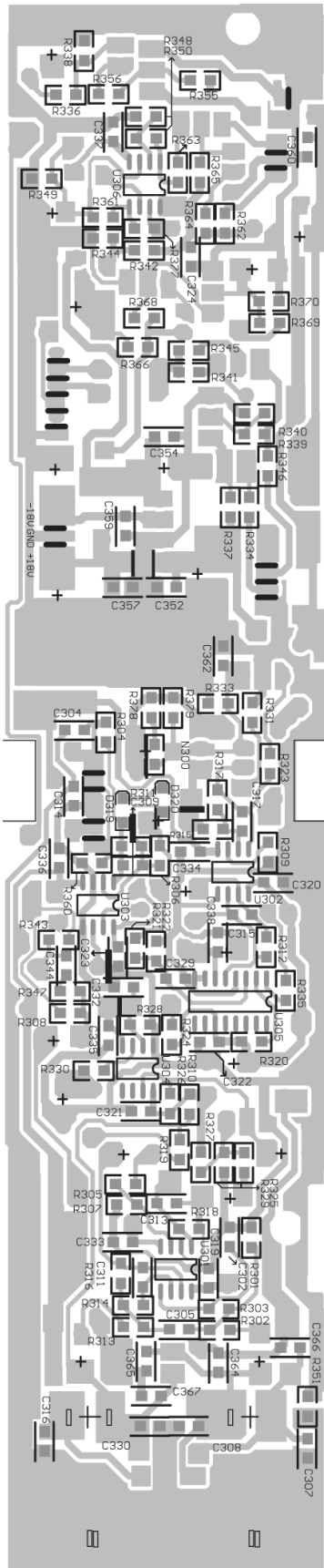

Figure 13. Input/Limiter PCB (RoHS)
Top Side Etch Layout

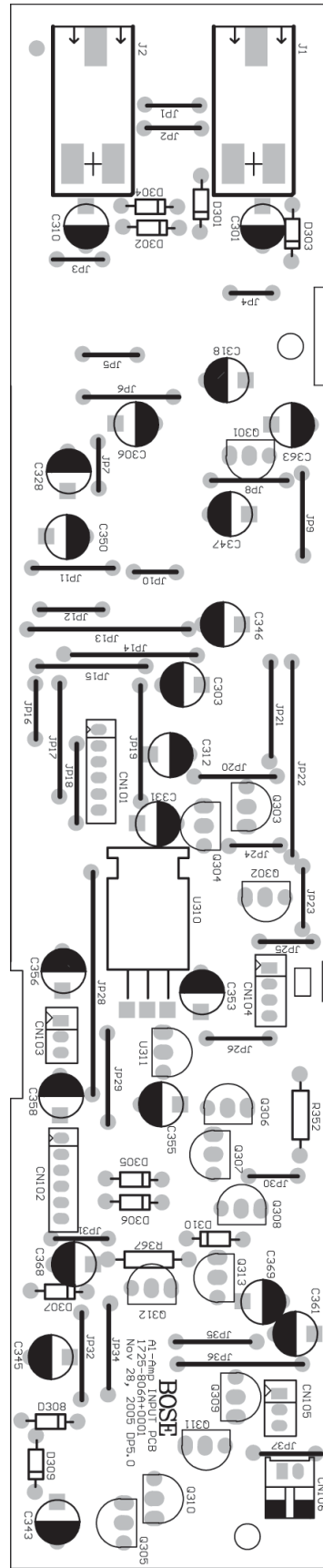

Figure 14. Input/Limiter PCB (RoHS)
Bottom Side Etch Layout

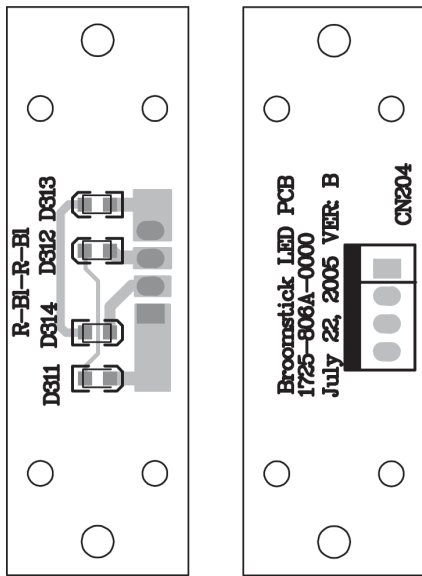

Figure 15. Power/Fault LED PCB Etch Layout

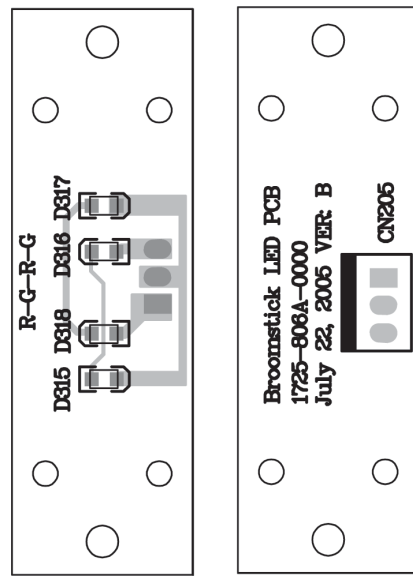
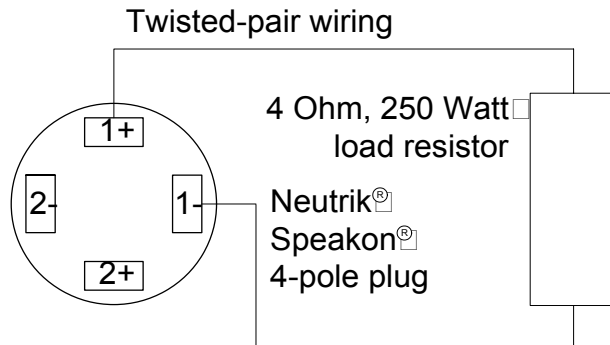

Figure 16. Signal/Overload LED PCB Etch Layout

Test Cable Wiring Diagrams



Part List

- Neutrik Speakon NL4FX connector
- 2 feet (1/2m) of 18 AWG twisted-pair stranded wire.
- 4 Ohm, 250 Watt load resistor

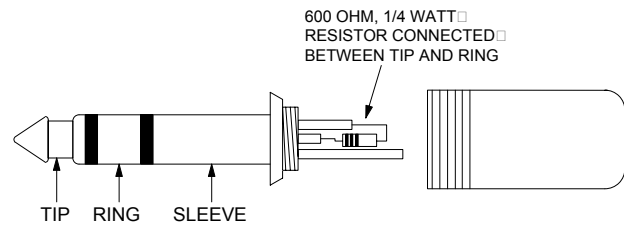

Part List

- Tip-Ring-Sleeve (TRS) 1/4" male plug
- 600 Ohm, 1/4 Watt resistor

Troubleshooting

Problem	What to do
Power LED is not lit; the amplifier does not seem to operate.	<ul style="list-style-type: none"> • Be sure power switch is ON. • Make sure the power cord is fully inserted into the unit and an AC outlet. • Be sure the AC outlet is live. Try operating a lamp or other equipment from the same AC outlet or test the outlet using an AC outlet tester.
Power LED is RED, not BLUE.	<ul style="list-style-type: none"> • Amplifier is in the Protect mode: <ul style="list-style-type: none"> – Thermal overload: Lower the level of the input signal. Be sure the amplifier is on a hard, flat surface to aid in heat dissipation. – Output is short-circuited: Check output connections/wires. – Driving too many speakers in parallel: Make sure you connected no more than two B1 bass modules to one A1 amplifier. – Impedance is too low: Make sure you connected only one 4-ohm or up to two 8-ohm speakers of other brands. – Input level is too high: Lower the level of the input signal. • The red light should no longer illuminate when a fault condition is removed. In the case of thermal overload, the amplifier may have to cool for a few minutes.
Signal LED is flashing RED.	<ul style="list-style-type: none"> • The input signal is near limit. Lower the input level so the red light flashes only occasionally, at peak volumes.
No audio, signal LED is GREEN.	<ul style="list-style-type: none"> • Speaker not connected properly. Check that output connections are correct and connectors are fully seated.
No audio, signal LED not lit.	<ul style="list-style-type: none"> • Power not connected. Check the power LED. It will shine BLUE when power is connected and the unit is turned on. • No signal going into the amplifier. Check input connections and input level. • Replace input cable.
A hum or buzz can be heard from the loudspeaker.	<ul style="list-style-type: none"> • If you are using a 1/4" TS (unbalanced) cable, use a 1/4" TRS cable (supplied with the A1 amplifier) between the source device and the A1 amplifier. • Plug the power cord of the PS1 or source device into the same AC (mains) power circuit as the A1.

THEORY OF OPERATION

PackLite™ Model A1 Amplifier

1. General Overview

The Personalized Amplification System™ family of products currently consists of the PS1 power stand, the L1 Cylindrical Radiator® loudspeaker and the B1 bass module. The PS1 power stand can power up to two B1 bass modules. This is sufficient for most instruments with the exception of some applications of bass guitar, drums (kick drum) and some types of recorded music playback. For these types of instruments, an attractive solution is to provide an additional power amplifier that can power two additional bass modules, and can be “daisy-chained” to power additional modules. The A1 PackLite power amplifier is designed primarily for this application, but also has the features required to be applicable as a general purpose power amplifier, specifically, input limiting and signal/clip LED indication.

The amplifier contains a line level input, a pass-through line-level output, and a switching power amplifier optimized for a 4 ohm load. In its normal use, the amplifier drives one or two (8 ohm) B1 bass modules. There are 120 and 230V versions for sale in the US and Europe/Australia.

2. Amplifier PCB Architecture

Note: Refer to the Amplifier Block Diagram, sheet 1 of 1 for the following. The information inside the brackets [] is the schematic grid location on the sheet.

The amplifier comprises two PCB's, a Switch Mode Power Supply (SMPS)/Amplifier PCB and an Input/Limiter PCB. The SMPS/Amplifier PCB filters the AC mains power, converts it to the DC voltages required by the audio amplifier and the input/limiter PCB, and provides a switching audio amplifier with 30 dB of gain.

The block diagram shows the amplifier board PCB architecture. The amplifier uses a three-wire, grounded AC power configuration, with the cast aluminum chassis connected to earth ground.

Connectors

The amp pcb has connectors for AC power (con300) [C1], line-level audio in (J301) [C4], speaker out (con301) [D4], control signals (J302) [B/C4], and DC voltage output (J303) [B4].

Switches

S301 [A3] is a DC bypass option for the ground connection, left open in production for best EMC performance. S302 [A1] was a design option to allow a second grounding point on the board, left closed in production for best EMC performance.

3. AC Power Input Filter Section

Note: Refer to the SMPS/Amplifier PCB Schematic Diagram, sheet 1 of 3 for the following.

L100, L101, C100, C109, C110, C111, and C112 [all located at B/C2] provide filtering to keep radio frequencies off the power supply for compliance with FCC and EN55103 emissions requirements. R102, R103, and R104 [B/C2] provide a DC discharge path for the capacitors on the input to discharge when power is removed.

L100 and L101 are progressively wound common mode chokes with an impedance peak greater than 450 kHz.

THEORY OF OPERATION

AC Power Input Filter Section (continued)

D100 [B/C3] rectifies the AC signal, which is filtered by C107 [C4] and C108 [B4].

N100 [C3] and N101 [B3] provide in-rush current protection when connected to the AC line.

MOV1 [C4] and MOV2 [B4] are for surge protection.

SG101 through 104 [B/C2] provide an ESD discharge path to the AC mains around the higher impedance of the coils.

S100 [B3] is a manufacturing option to control use for 120 or 230 VAC. The StartUp signal must be over 9 volts for the converter circuitry to start.

4. Converter Section Circuitry

Note: Refer to the SMPS/Amplifier PCB Schematic Diagram, sheet 2 of 3 for the following. The information inside the brackets [] is the schematic grid location on the sheet.

The DC to DC converter is a transformer isolated but unregulated switching power supply. Output voltages are generated by the secondary windings, and consist of:

- Vss/Vdd: +/-5VDC regulated
- +/-18VDC for the limiter board (+/-16.5 to 29 VDC)
- Amp Vd / Amp Vs - Amplifier rail voltages: +/-40VDC (+/- 30to 45.5)
- Vdrive: 10V above Vs, regulated, for internal use

R200 [C1] and C200 [B1] set up a 100 kHz oscillating frequency for the half bridge driver IC200 [C1] which controls Q200 [C2] and Q201 [B2] to provide the high current switching.

N201 [A3] forms a resistive divider with R290 [B2], and turns on Q290 [A3] if the temperature at the converter rises above 130 degrees C. Q290 turns the half bridge driver off.

N200 [D4] protects the rectifying diodes on the amplifier DC rails from overheating by bringing Enable low if the temperature goes too high, shutting off the amplifier section.

R206 [C2] in parallel with R207 [B2], and R213 [C2] in parallel with R214 [B2] improve current sensing. If the DC current in the FETs goes above ten amps, Q205 [D2] and Q210 [D2] will shut down Q200 [C2], or Q206 [A2] and Q207 [A2] will shut down Q201 [B2].

5. Amplifier Section

Note: Refer to the SMPS/Amplifier PCB Schematic Diagram, sheet 3 of 3 for the following.

Refer to the Appendix for pinout diagrams and block diagrams for the amplifier chipset consisting of ICCI (reference designator IC3) and ICEdrive1 (IC1 and IC2).

The PackLite™ A1 amplifier is designed to provide 30 dB of gain, and drive 250 W into a 4 ohm load. It is a dual amp used in a bridged configuration. The pcb has the capability of being configured for two channel use, but is not used for two separate channels in this product.

THEORY OF OPERATION

Amplifier Section (continued)

IC4A and IC4B [D2] provide buffers for the audio input, and provide the ability to accept balanced or unbalanced inputs. The PackLite™ A1 amplifier uses the inputs in an unbalanced configuration.

R21, R24, R25, R26 [A/B3] provide resistive dividers to determine the under and over-voltage protection thresholds.

R36 [C3] is assembled (0 Ohms), and R37 [C3] is not, which turns off the on-chip under-voltage protection feature. See Pre-amplifier Enable Circuitry in section 6 for under-voltage protection. N1 and R18 [C6] provide a temperature-sensitive voltage to protect the output FETs. The voltage is fed to ICC1 [C3] where it can initiate a thermal shutdown of the amplifier above 120 degrees C, and is brought externally to J302, pin 1 [Input/Limiter PCB Schematic Sheet 1, C8].

Other signals provided externally on connectors:

- Enable (bidirectional/open collector, can signal that the amp has shut down, or can be used to shut down the amp)
- OC – output, over current protection, or Zobel protection is active
- TH – output – signals that the amp has shut down based on it's NTC input (N1)
- Vdd – 5 Volts output for detection tht power is on
- Control Ground

C45 [D2], C65 [C8], C66 [B8], and R40 [C8] are not assembled. L8 [C8] provides common mode filtering of radio frequencies for FCC and EN55103 emissions compliance.

The voltage on the Zobel network is divided by R15 [C6] and R17 [C7] (and R31 [A6], R32 [A7]) and sensed by IC3 (ICC1) [C3], and will shut down the amplifier as represented below in the following curve:

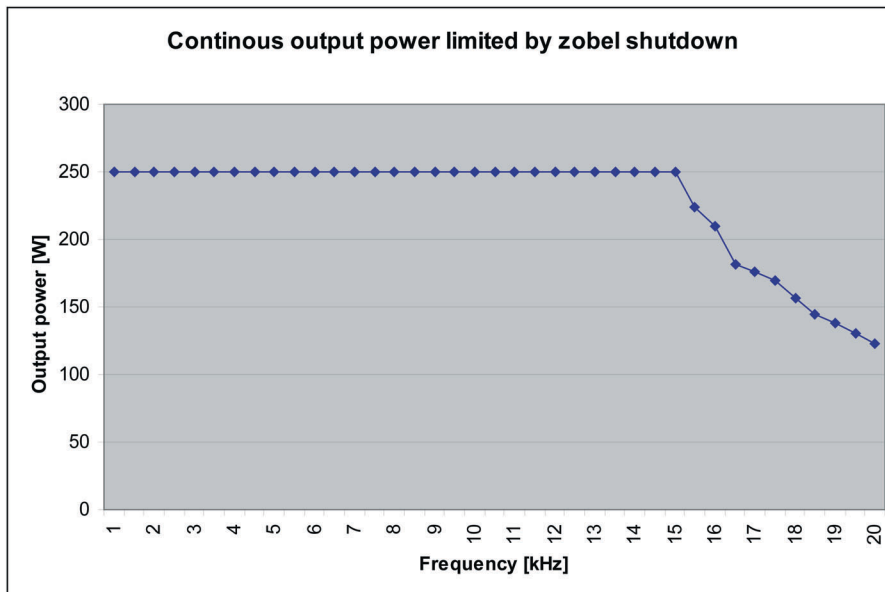

THEORY OF OPERATION

6. Input/Limiter PCB Assembly

Note: Refer to the Input/Limiter PCB Schematic Diagram, sheet 1 of 1 for the following. The information inside the brackets [] is the schematic grid location on the sheet.

The Input/Limiter PCB assembly provides:

- Input buffering for line level signals
- Input short circuit and ESD protection
- Power regulation for audio
- Automatic gain change for balanced or unbalanced input signals
- Limiting
- Hard clipping for very large transient signals
- LED control
- Cooling fan control
- Under-voltage detection and ENABLE control for the power amplifier.

Gain Structure of the Input/Limiter PCB

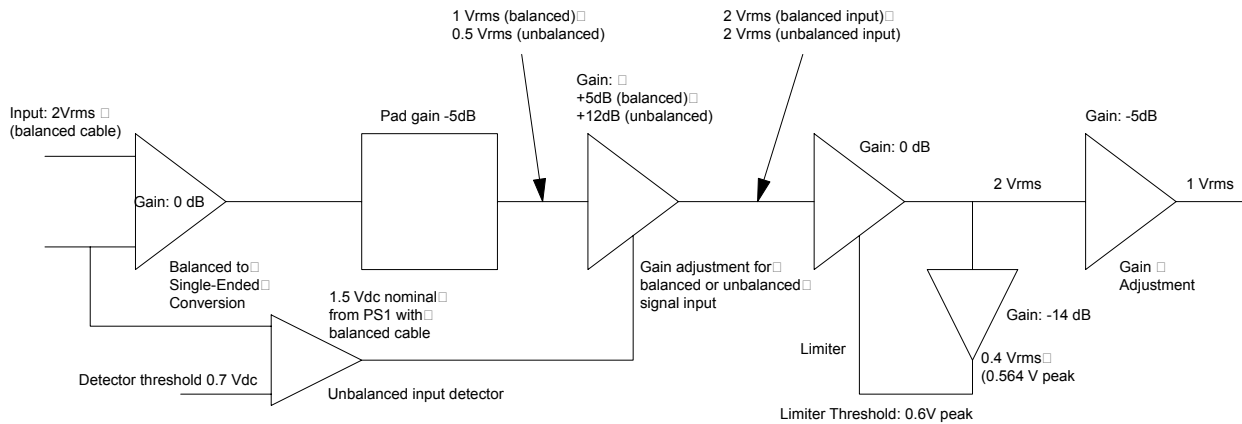

The overall gain of the preamplifier pcb, when not limiting, is unity for unbalanced signals, and -6 dB for balanced signals. It is designed to keep the steady-state signal output below approximately 0 dBV, and hard clip transients to about 5 V peak

Input Buffer

J1 [D1] and J2 [C1] are balanced TRS connectors to provide an input jack and a “pass-through” parallel connection. D301 through D304 [D1 to D3] provide input short circuit protection and ESD protection by clamping to the power supply rails. C307, C308, C316 and C330 [C/D1] provide RF decoupling as well as additional ESD protection to the input. C364 through C367 [D1 to D3] are not installed on production units.

U301B [D3] is a Bessel filter with a relatively high input impedance of 40k Ohms. This input impedance was selected to avoid low frequency roll-off with the PS1 power stand bass line output used as an input. The PS1 has a relatively high impedance with a capacitance of 2.2 uF in series with 560 Ohms.

THEORY OF OPERATION

Input/Limiter PCB Assembly (continued)

Power Regulation

+/-18 VDC is brought to the preamp pcb from the amplifier power converter. A total of 500 mA can be drawn from these two supplies. In this application the supplies are linearly regulated to +/-15 V to use for audio amplifier rails, and to drive LEDs. The linear regulators are U310 and U311 [B/C7].

Balanced/Unbalanced Detection

The PackLite™ A1 amplifier is primarily used with the bass line output of a PS1 Power Stand, which is a balanced output. We require 24 dB of gain in that case. If a user connects to a PS1 using an unbalanced cable, they will lose 6 dB of signal going into the PackLite A1. In that case, U304 [C2] will detect that RING is connected to SHIELD, which is grounded, and, after a few seconds, will increase the gain of U301A [D4] by 6 dB in order to compensate. This way the user will always have the correct gain whether they use a balanced or an unbalanced cable. The RING connector is tied to V+ through R310 [C2], then low-pass filtered by R319 and C328 [C2] with a time constant on the order of a second. This voltage is compared to a reference (R324 and R328 [C2]), and if it goes below 700 mV, U304 output goes high to turn on Q301 [C3].

Gain Switch

After a 6 dB pad consisting of R305 and R307 [D3], the gain of U301A [D4] is +12 dB for unbalanced signals, and +6 dB for balanced signals. It is derived as follows:

Assuming the open loop gain of the opamp is large, the voltage gain is expressed approximately as $\text{Gain} = 1/K$, where K is the voltage divider created by two impedances, Z1 and Z2:

$\text{Gain} = G(\text{open loop}) / (1 + (G(\text{open loop}) K))$,
approximately = $1/K$

$$K = Z2/Z1 + Z2$$

$$Z1 = R318 // C318$$

$$Z2 = Z(C318) + R325 + R327 // R329$$

C313 [D4] is chosen to provide a low-pass corner at 100 kHz, well above the audio band, and C318 [C3] is chosen large enough to provide DC blocking with a corner below 10 Hz. So, for mid-band calculations, $Z1 = R318$, and $Z2 = R325 + R327 // R329$, providing a gain of +6 dB when Q301 is off (balanced input case).

When Q301 [C3] is on, it essentially shorts the R327//R329 [C3/4] combination to provide an impedance of 0, so the overall gain becomes +12 dB. Although R329 connect to positive DC voltage in order to bias Q1's emitter, and R327 connects to ground, both of those connections are small-signal (AC) ground, and are shown in parallel.

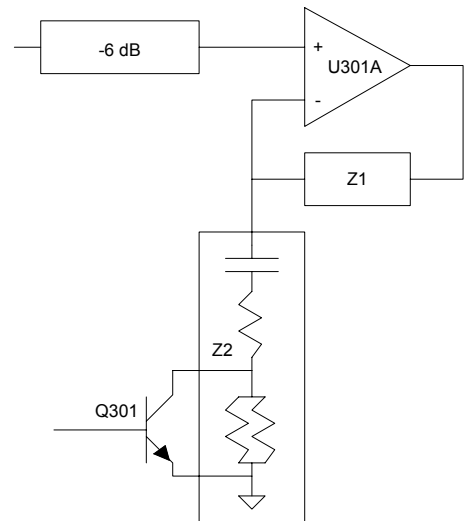

THEORY OF OPERATION

DC Offsets

Because of the DC offsets involved (the RING of the input jack is connected to a DC voltage and will momentarily shift when a plug is inserted into the jack), there can be a clicking sound output from the amp when plugs are inserted or removed from the input jacks, as well as when the gain changes. This is normal operation for the circuit, and while not ideal, is usually avoided by the user by keeping the power off while inserting or removing plugs.

Limiter

The limiter circuit's limiting rate is dependent on the input signal level, that is, a larger input will cause the gain to lower faster.

U305 [C4] is an Operational Transconductance Amplifier configured as a voltage-controlled resistor in the feedback loop of U302B [D5]. As the AC signal level at U302A [D6], pin 1 increases past one base-emitter junction voltage, it will turn on either Q303 or Q302 [C6], both of which will discharge the base of Q304, increasing the current into the control pin of U305 through Q304's collector. This has the effect of lowering the gain once the signal exceeds a threshold. The limiting threshold can be set by adjusting the gain of U302, and thereby the amount of level fed into Q302 and Q303. The unlimited gain is about unity.

R378, R333 and N300 [C5] are chosen to keep Q304 just off until the threshold is increased. If the quiescent voltage at the base of Q304 is too high, there will be a delay when an input signal reaches the limiting threshold, as C331 [C5] discharges enough to turn on Q304. N300 compensates for temperature differences. Since V_{be} gets smaller at higher temperatures, as N300 goes low in resistance at high temperatures, it dominates and compensates the smaller V_{be} on, but as it goes very high in resistance (at low temperatures), R-new keeps the resistance from going too high.

The attack time of the limiter is set by the C331/R323 and R331[C6], and is on the order of single milliseconds. The release time of the limiter is set by C331 with R333, and is set to be on the order of 100 msec.

Hard Limiting

If the input signal exceeds the input voltage limit of the input buffer amp, about +18 dBV steady state, the signal will clip in the input amp, and the limiter will bring the overall level down appropriately. However, because transient signals can pass through the limiter before it has time to lower the gain, it is possible for transients above the limiting level to appear on the input of U303 [D7]. These transients could put too large an instantaneous demand on the amplifier converter current, causing it to enter a protection mode. To avoid this, the output of U303 is limited to less than +5VDC by zener diodes D319 [D6] and D320 [D7]. The 3V zener voltage was chosen empirically to provide clipping without adding too much distortion from partial turn-on in the useful audio range.

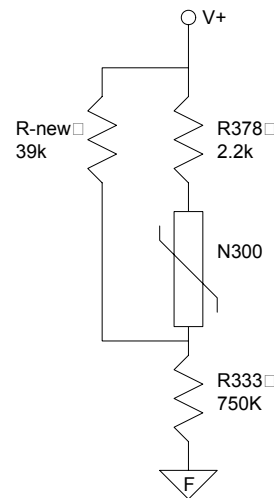

THEORY OF OPERATION

Fan Control

The fan turns on when the signal level is high, rather than using a thermal detector. When the input signal reaches about -10 dBV, the Q305/Q310 [B2] combination will turn on the fan.

LED Control

The green signal LED will turn on at an input level of about -26 dBV. The red LED will turn on at about +1 dBV, when the pre-amplifier will begin to limit. U306A [B2] and U306B [A3] detect the on-levels for the green and red LEDs, respectively. Q309 [B3] turns off the green led when the red turns on.

The blue power LED will turn on whenever power (+18VDC) is present, and will change to red if the OC (overcurrent) or TH (thermal) signals from the amplifier IC are present. Those signals are OR'ed through D305 and D306 [B5]. Q308 turns on if either fault condition is present, and turns on the red LED. Q307 [B4] is used to shut off Q306 [B4] and the green LED.

Under-voltage detection and ENABLE control

The ENABLE circuitry provides an output that will disable the amplifier under two conditions:

1. On power up for a couple seconds
2. If the +/- 18VDC supply goes below 16 VDC.

The purpose of disabling the amplifier on power up is to provide a stabilization time to avoid large output signals on the speaker output. The purpose of monitoring the +/-18VDC level is to provide under-voltage protection for the amplifier. Because the power converter on the amp board is not regulated, nor is the +/-18 VDC supply, which is derived from the same transformer primary, the 18V supply will track the other voltages in the set. Most importantly, the amp rails at +/-40V are the highest current consumers and the most likely to cause a voltage sag. If the load is too heavy on the amplifier, causing the rail voltage to sag, the 18 V will also sag proportionally, and the amp is shut down to protect itself. This can happen at low but still operable AC mains voltages with very high output power demands, or with actual under-voltage conditions in an AC mains power brownout or dropout.

D310 [B7] in series with R369 and R370 [B6] provide a voltage to compare to the 0.7V NPN turn-on voltage. As long as the +18 V supply is above 16 V, Q313 [B7] stays on, keeping Q312 off, and EN is pulled high by R366 (and limited to 5V by zener D307). If Q313 is turned off, then Q312 turns on, bring EN low. At that point, as well as during power up, even when the +18V is valid, there will be a few second delay before enabling as C368 charges through R366.

On power down, ENABLE is brought low relatively quickly by Q312 turning on.

THEORY OF OPERATION

7. Protection Mechanism Summary

Fault	Detection	What shuts down	Indicator Output	Recovery when fault is removed	Notes	Fault LED
Input Signal Level Clipping	Output signal level re: 0.865 of amplifier DC supply	Per channel	None	Immediate	Detection threshold tied to DC over/under voltage threshold	NO
Output Signal Current Limit	Output MOSFET 'on' voltage	Per MOSFET	None	Immediate	FET is shut off for short time (1.25 usec) then restored causing "self-oscillation"	NO
Output Over-current /O.C. (short circuit, saturation)	Detects output current limit over a settable time constant	Per channel	OC	Time settable by resistor value	Time constants shared with Zobel protection	RED
Zobel Protection	Over-voltage across Zobel resistor	Shutdown per channel	OC	Time settable by resistor value	Shared time constant with OC	RED
Thermal	External Negative Temperature Coefficient resistor - threshold detection with hysteresis	Both amplifiers	TH	System turns back on when NTC when voltage above threshold (depends on thermal constant of system)	One NTC resistor per system - will be two	RED
Amp DC voltage over/under	Percentage of amplifier DC supply voltage (typically 135%). Under voltage detection optional to insure controlled startup.	Both amplifiers	EN	Capacitors are given a discharge path to prevent long recovery time - but enable circuit has long recovery	Detection threshold tied to input signal clipping threshold	NO
Control Voltage (5 Vdc) DC over / under	Percentage of 5V voltage	Both amplifiers	EN	Immediate		NO
Converter	Over-current	System	None	Immediate		NO
Converter	Thermal	System	None	Depends on thermal constant of system		NO

Integrated Circuit Diagrams

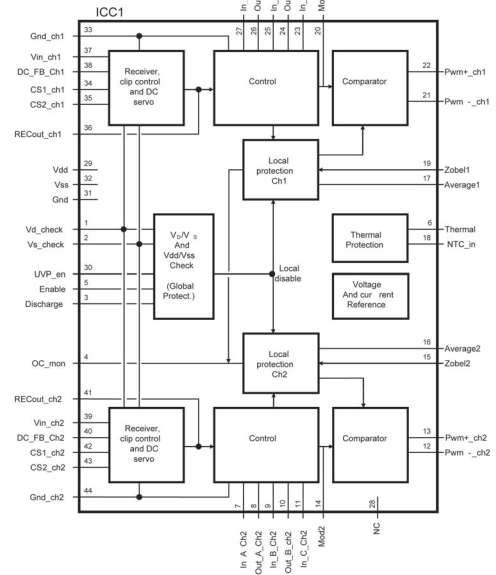
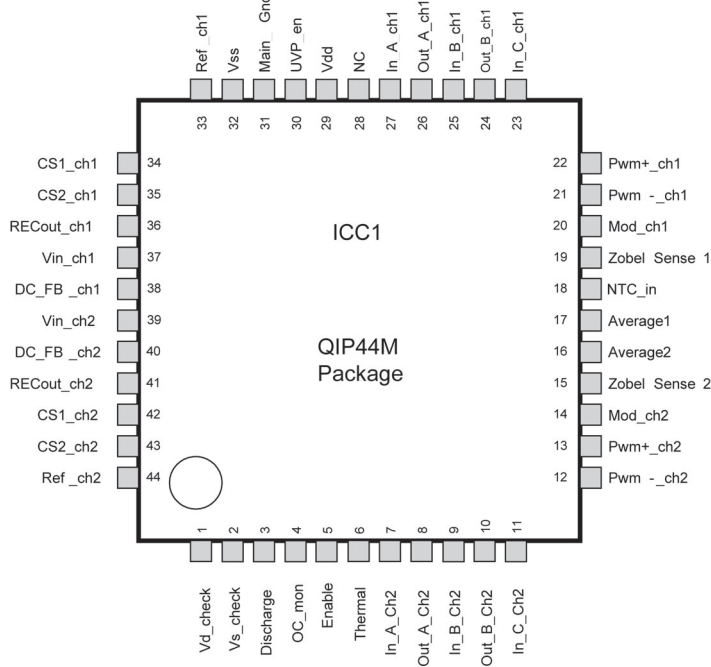

Pin	Pin name	Description
1	Vd_check	High impedance input for monitoring the positive power stage voltage. This controls the soft clipping circuit and the over and under voltage shut down.
2	Vs_check	Same as above for the negative rail.
3	Discharge	High impedance output that generates a current in case of an over-voltage condition on the power stage voltages (Vs/Vd). This current is designed to turn-on a set of discharge transistors.
4	OC_mon	Monitors the state of the control loop and the average voltage across the zobel resistor, and will turn on in case of of-limit conditions.
5	Enable	Bi-directional input/output.
6	Thermal	Open collector output for over temperature warning.
7	In_A_Ch2	Connects the external loop components. Virtual ground summing pin.
8	Out_A_Ch2	Connects the external loop components. Op-amp output pin.
9	In_B_Ch2	Connects the external loop components. Virtual ground summing pin.
10	Out_B_Ch2	Connects the external loop components. Op-amp output pin.
11	In_C_Ch2	Connects the external loop components. Virtual ground summing pin.
12	Pwm-_ch2	The first of two balanced high impedance current comparator output. This output is connected via level shift transistors to the driver.
13	Pwm+_ch2	The second of the balanced high impedance current comparator output. When both of these outputs are low (Pwm-_ch2 and Pwm+_ch2) the driver will regard this as a disable. This is the way the disable is communicated to the driver.
14	Mod_Ch2	Connects the external loop components. Op-amp output pin connected to the modulation comparator.
15	ZobelSense2	Estimates the power dissipation in the zobel resistor this input is sensing the zobel voltage via a resistive network. Channel 2.
16	Average2	For the averaging function in ch 2 of the OC monitor a capacitor is connected to this pin.
17	Average1	For the averaging function in ch 1 of the OC monitor a capacitor is connected to this pin.
18	NTC_in	Comparator input for connection of an NTC resistor. When detection a hysteresis current of 100uA is sourced via this pin.

LV4930M (IC3) Block Diagram and Pin Function Table

Integrated Circuit Diagrams

Pin	Pin name	Description
19	ZobelSense1	Same as pin 15, but for ch 1.
20	Mod_ch1	Pin for connecting the external loop components. This pin is an op-amp output pin and is connected to the modulation comparator.
21	Pwm-_ch1	The first of two balanced high impedance current comparator output. This output is connected via level shift transistors to the driver.
22	Pwm+_ch1	The second of the balanced high impedance current comparator output. When both of these outputs are low (Pwm-_ch1 and Pwm+_ch1) the driver will regard this as a disable. This is the way the disable is communicated to the driver.
23	In_C_Ch1	Connects the external loop components. Virtual ground summing pin.
24	Out_B_Ch1	Connects the external loop components. Op-amp output pin.
25	In_B_Ch1	Connects the external loop components. Virtual ground summing pin.
26	Out_A_Ch1	Connects the external loop components. Op-amp output pin.
27	In_A_Ch1	Connects the external loop components. Virtual ground summing pin.
28	NC	No connection
29	Vdd	Positive supply pin
30	UVP_en	Enables the Under Voltage Protection by connecting to Vdd and disabling by connecting to Vss.
31	Main_Gnd	General ground for protection and all miscellaneous circuits.
32	Vss	Negative supply
33	Ref_ch1	Input reference for channel 2. This pin is a local ground reference for the audio circuit of this channel. It is not connected internally to main ground.
34	CS1_ch1	Pin for connection of capacitor for the dc servo. This pin is the output of the internal dc servo amplifier.
35	CS2_ch1	Pin for connection of capacitor for the dc servo. This pin is virtual ground.
36	REOut_ch1	This pin is the ch1 receiver output after an internal series resistor of 1k. By connecting a capacitor to ground a low pass function is obtained. From this pin the signal is internally passed on to the output stage.
37	Vin__ch1	High impedance audio input. This input is non-inverting.
38	DC_FB_ch1	DC servo feedback point. This is a low impedance point with a correction voltage of +/- 100mV range. Connect to input via a resistor of 47kohm.
39	Vin_ch2	High impedance audio input. This input is non-inverting.
40	DC_FB_ch2	DC servo feedback point. This is a low impedance point with a correction voltage of +/- 100mV range. Connect to input via a resistor of 47kohm.
41	REOut_ch2	This pin is the ch2 receiver output after an internal series resistor of 1k. By connecting a capacitor to ground a low pass function is obtained. From this pin the signal is internally passed on to the output stage.
42	CS1_ch2	Pin for connection of capacitor for the dc servo. This pin is the output of the internal dc servo amplifier.
43	CS2_ch2	Pin for connection of capacitor for the dc servo. This pin is virtual ground.
44	Ref_ch2	Input reference for channel 2. This pin is a local ground reference for the audio circuit of this channel. It is not connected internally to main ground.

Integrated Circuit Diagrams

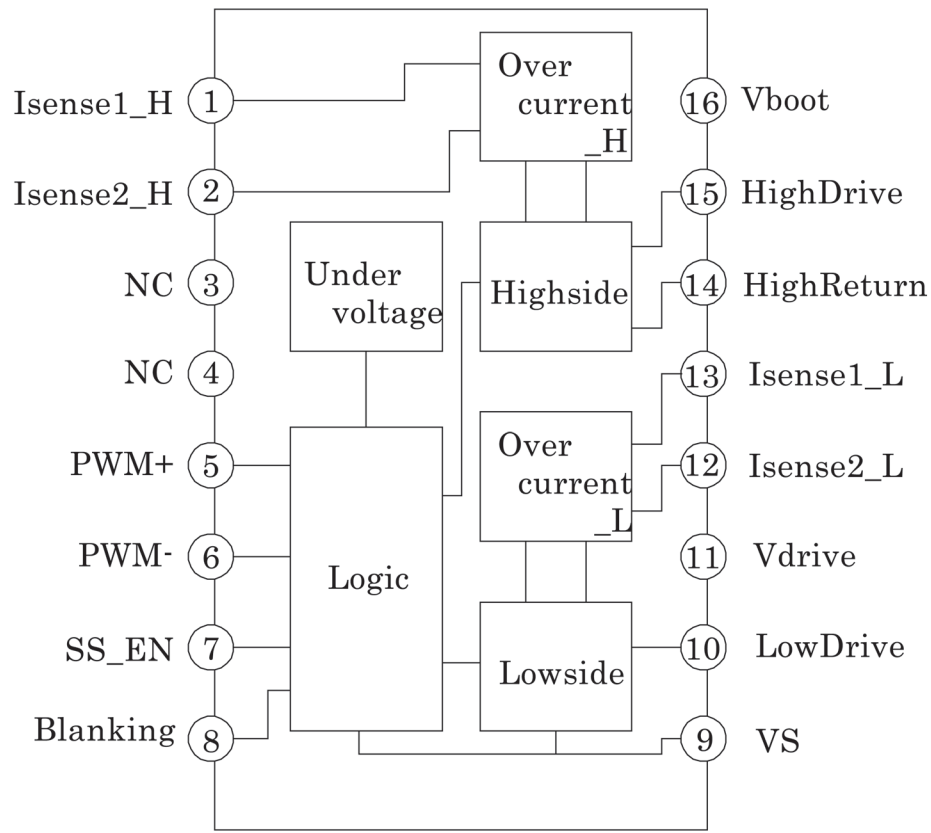

Pin No.	Pin Function	Description
1	Isense1_H	Over current sensing_1 for High side
2	Isense2_H	Over current sensing_2 for High side
3	NC	Non connection
4	NC	Non connection
5	PWM+	Input plus
6	PWM-	Input minus
7	SS_EN	Safe start enable
8	Blanking	Dead time control
9	VS	Negative supply of chip
10	LowDrive	Low side Output
11	Vdrive	Positive supply of Low side
12	Isense2_L	Over current sensing_1 for Low side
13	Isense1_L	Over current sensing_2 for Low side
14	HighReturn	Negative supply of High side
15	HighDrive	High side Output
16	Vboot	Positive supply of High side

LV4970M (IC1 and IC2) Block Diagram and Pin Function Table

Service Manual Revision History

Date	Revision Level	Description of Change	Change Driven By	Pages Affected
10/05	00	Document released at revision 00.	Service manual release	All
3/06	01	Added theory of operation and IC block diagrams	Additional information available	38-48
7/06	02	Added RoHS compliant amplifier version information	RoHS compliance initiative	9, 13-29, 35-40

SPECIFICATIONS AND FEATURES SUBJECT TO CHANGE WITHOUT NOTICE

BOSE[®]
Better sound through research[®]

Bose Corporation
The Mountain
Framingham Massachusetts USA 01701

P/N: 283300-SM Rev. 02; 7/2006 (P)
<http://serviceops.bose.com>