

# Bose® Model 1800-VI and 1600-VI Professional Stereo Power Amplifier

## Owner's Guide

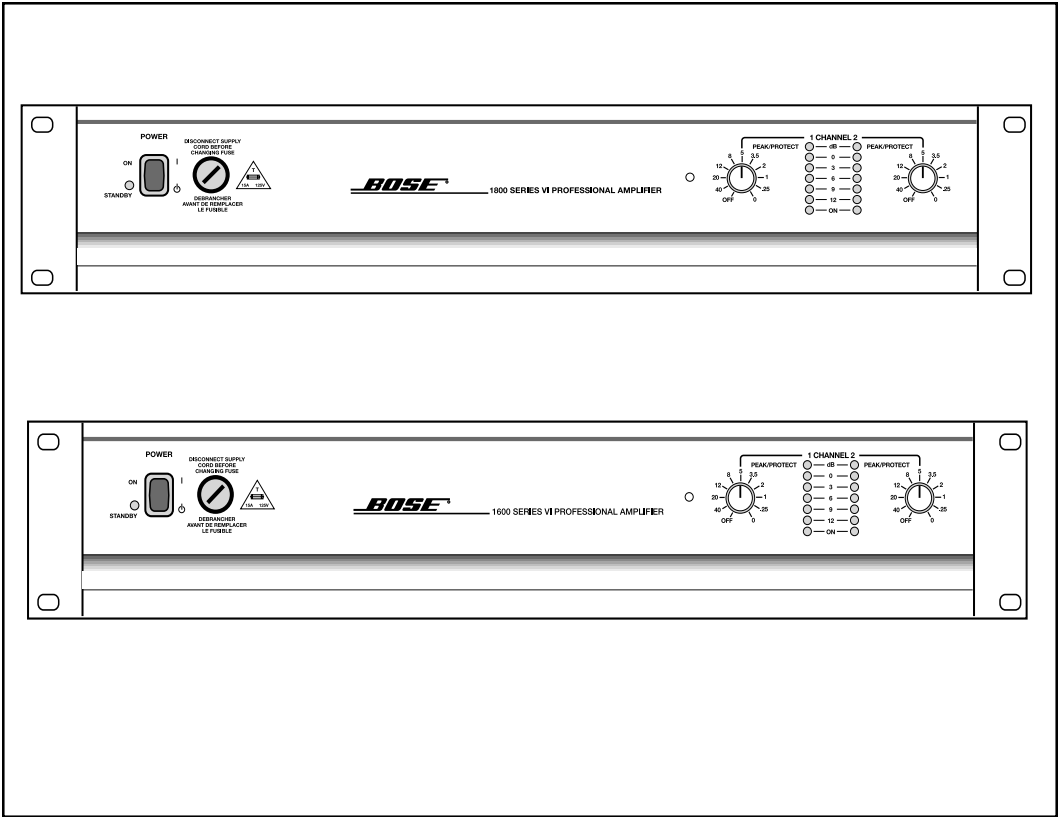

### Warning

To reduce the risk of fire or electric shock, do not expose the unit to rain or moisture.

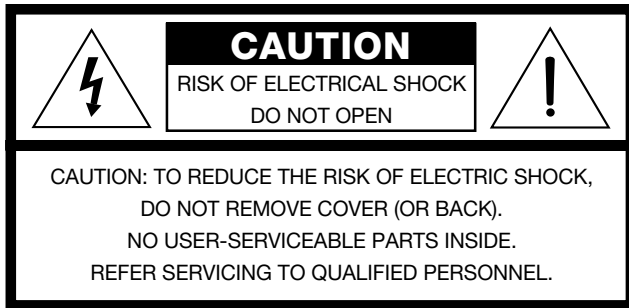

These CAUTION marks are located on the back of the Model 1800-VI or 1600-VI Professional Stereo Power Amplifier.



The lightning flash with arrowhead symbol, within an equilateral triangle, is intended to alert the user to the presence of uninsulated dangerous voltage within the system enclosure that may be of sufficient magnitude to constitute a risk of electric shock.



The exclamation point within an equilateral triangle, as marked on the system, is intended to alert the user to the presence of important operating and maintenance instructions in this owner's guide.

### Information about products that generate electrical noise

If applicable, this equipment has been tested and found to comply with the limits for a Class A digital device, pursuant to Part 15 of the FCC Rules. These limits are designed to provide reasonable protection against harmful interference in a residential installation. This equipment generates, uses, and can radiate radio frequency energy and, if not installed and used in accordance with the instructions, may cause harmful interference to radio communications. However, this is no guarantee that interference will not occur in a particular installation. If this equipment does cause harmful interference to radio or television reception, which can be determined by turning the equipment off and on, you are encouraged to try to correct the interference by one or more of the following measures:

- Reorient or relocate the receiving antenna.
- Increase the separation between the equipment and receiver.
- Connect the equipment to an outlet on a different circuit than the one to which the receiver is connected.
- Consult the dealer or an experienced radio/TV technician for help.

### Please read this owner's guide

The Model 1800-VI and 1600-VI Professional Stereo Power Amplifiers are carefully engineered to provide sound quality far beyond other music systems. This guide will help you set up and operate your system properly.

### Record your serial number here:

Model 1800-VI Professional Stereo Power Amplifier: \_\_\_\_\_

Model 1600-VI Professional Stereo Power Amplifier: \_\_\_\_\_

Date of purchase \_\_\_\_\_ Retailer's name \_\_\_\_\_

For ease in obtaining service, we recommend that you keep your purchase receipt, or a copy of the receipt, in this owner's guide.

## Atención

Para reducir el riesgo de incendio o descarga eléctrica, no exponga este aparato a la lluvia ni a la humedad.

	<b>PRECAUCIÓN</b> PELIGRO DE DESCARGA ELÉCTRICA NO ABRIR	
<p>ATENCIÓN: PARA REDUCIR EL RIESGO DE SUFRIR UNA DESCARGA ELÉCTRICA, NO RETIRE LA CUBIERTA (NI LA TAPA TRASERA). EN EL INTERIOR DEL APARATO NO HAY NINGUNA PIEZA CUYO MANTENIMIENTO PUEDA REALIZAR EL USUARIO. TODAS LAS OPERACIONES DE MANTENIMIENTO DEBEN SER REALIZADAS POR PERSONAL CUALIFICADO.</p>		

Estas marcas de ATENCIÓN están situadas en la parte posterior del amplificador de potencia estéreo profesional Modelo 1800-VI o 1600-VI.



El símbolo de relámpago dentro de un triángulo equilátero indica al usuario que en el interior de la carcasa del sistema existen tensiones peligrosas no aisladas de intensidad suficiente como para representar un riesgo de sufrir una descarga eléctrica.



El signo de admiración dentro de un triángulo equilátero, como el que aparece marcado en el sistema, indica que en la guía del usuario se ofrecen instrucciones de manejo y mantenimiento importantes

## Avvertenza

Per ridurre il rischio d'incendio o di scossa elettrica, non esporre l'unità alla pioggia o all'umidità.

	<b>ATTENZIONE</b> RISCHIO DI SCOSSA ELETTRICA NON APRIRE	
<p>ATTENZIONE: PER RIDURRE IL RISCHIO DI SCOSSA ELETTRICA, NON RIMUOVERE IL COPERCHIO (O IL PANNELLO POSTERIORE). NON VI SONO PARTI INTERNE RIPARABILI DALL'UTENTE. PER LA MANUTENZIONE, RIVOLGERSI A PERSONALE AUTORIZZATO.</p>		

I simboli di AVVERTIMENTO qui riprodotti rappresentano i simboli che si trovano sul pannello posteriore degli amplificatori di potenza stereo professionale Modello 1800-VI e Modello 1600-VI.



Il simbolo del lampo con la freccia, racchiuso in un triangolo equilatero, avverte l'utente che all'interno dell'apparecchio vi sono parti non isolate sotto tensione di entità tale da provocare scosse elettriche.



Il punto esclamativo all'interno di un triangolo equilatero, come presente sul sistema, avverte l'utente dell'esistenza di importanti istruzioni d'uso e di manutenzione contenute in questo manuale.

### Waarschuwing

Om het gevaar voor brand of elektrische schokken te verminderen, mag het toestel niet aan regen of vocht worden blootgesteld.



Deze waarschuwingssymbolen bevinden zich op de achterkant van de Model 1800-VI en 1600-VI professionele stereo vermogensversterker.



De bliksemstraal met pijlpunt in een gelijkzijdige driehoek dient om de gebruiker erop attent te maken dat er niet-geïsoleerde, gevaarlijke spanning in de kast van het apparaat aanwezig is, die voldoende kan zijn om gevaar voor elektrische schokken op te leveren.



Het uitroepteken in een gelijkzijdige driehoek, zoals op het apparaat gebruikt, dient om de gebruiker erop attent te maken dat deze gebruiksaanwijzing belangrijke instructies voor bediening en onderhoud bevat.

**Where to find...**

1.0 Safety Information ..... 2

2.0 Before You Begin..... 6

    2.1 Unpacking the amplifier ..... 6

3.0 The Bose® Model 1800-VI and 1600-VI Professional Stereo Power Amplifiers ..... 6

4.0 Installation..... 7

    4.1 Location and general precautions ..... 7

    4.2 Mechanical considerations ..... 7

        4.2.1 Rear support for road applications ..... 7

    4.3 Thermal considerations ..... 7

    4.4 AC power considerations ..... 7

    4.5 Magnetic leakage consideration ..... 7

    4.6 Input wiring ..... 8

        4.6.1 Balanced operation ..... 8

        4.6.2 Unbalanced operation ..... 9

    4.7 Input sensitivity ..... 11

    4.8 Output wiring..... 12

        4.8.1 Polarity ..... 12

        4.8.2 Dual mono ..... 12

        4.8.3 Bridged mono ..... 13

        4.8.4 Parallel mono ..... 13

    4.9 Clipping eliminator ..... 13

5.0 Operation ..... 14

    5.1 Using the Bose® Model 1800-VI or 1600-VI Professional Stereo Power Amplifier ..... 14

    5.2 Input modules ..... 14

        5.2.1 Standard input module ..... 14

        5.2.2 ACM-1 amplifier control module ..... 14

    5.3 Front panel ..... 14

        5.3.1 Power switch ..... 15

        5.3.2 Standby LED ..... 15

        5.3.3 AC power fuse ..... 15

        5.3.4 Level controls ..... 15

        5.3.5 Status indicators ..... 15

        5.3.6 Data receive indicator ..... 15

    5.4 Rear panel ..... 16

        5.4.1 Stereo/mono switch ..... 16

        5.4.2 Clipping eliminator switch ..... 16

        5.4.3 Input connectors ..... 16

        5.4.4 EQ OUT connectors ..... 17

        5.4.5 Equalizer LEDs ..... 17

        5.4.6 EQ Bi-Amp/full range switch ..... 17

        5.4.7 Level defeat switch ..... 17

        5.4.8 Sequencer connector ..... 17

        5.4.9 Speaker outputs ..... 18

        5.4.10 Power cord ..... 18

6.0 Troubleshooting ..... 19

7.0 Features ..... 20

8.0 Warranty, Service ..... 21

9.0 Specifications ..... 22

Appendix: Technical Data Sheets (Español, Italiano, Nederlands)

Bose® Corporation ..... inside back cover

## 2.0 Before You Begin

Congratulations on your purchase of a new Bose® Professional Stereo Power Amplifier. It is backed by state-of-the-art engineering and manufacturing techniques to bring you the best in quality craftsmanship and reliable performance.

### 2.1 Unpacking the amplifier

Carefully unpack your amplifier. Keep the original carton and packing materials for possible future use. Check for any visible signs of damage. If the amplifier appears damaged, do not try to use it. Notify the Bose Product Support or your authorized Bose Professional Products dealer.

## 3.0 The Bose Model 1800-VI and 1600-VI Professional Stereo Power Amplifiers

The Bose Model 1800-VI and 1600-VI Professional Stereo Power Amplifiers are specially designed for professional sound applications. Their rugged construction and low profile allow each amplifier to sustain the abuses of the road with reliability and space-saving economy. Also, their accurate sound and ample power make these amplifiers ideal for critical studio applications.

The 1800-VI amplifier is rated at 600 watts per channel into 4 ohms and 450 watts per channel into 8 ohms. In bridged mono operation, it is rated at 1400 watts into 8 ohms.

The 1600-VI amplifier is rated at 325 watts per channel into 4 ohms and 240 watts per channel into 8 ohms. In bridged mono operation, it is rated at 700 watts into 8 ohms.

The sophisticated protection circuits designed into each amplifier will protect your system from unexpected faults. They also protect each amplifier from excessive temperature, continuous current limiting, and shorted outputs.

The balanced inputs of each amplifier use a high quality, high common-mode rejection differential amplifier for exceptional hum and noise rejection.

In addition, both the 1800-VI and the 1600-VI amplifiers are equipped with an input board that allows different equalization for each channel (provided the correct equalization card is installed). Equalization cards (EQ cards) are available for Bose 402®, 502®A, 502B, and 802® loudspeakers.

A sample setup might involve one Model 1800-VI amplifier driving two channels of 802 loudspeakers in stereo mode. A second Model 1800-VI could be added to drive a 502B module. Alternatively, just one amplifier could be used to drive the 802 loudspeakers on one channel and the 502B module on the other channel. Many configurations are possible using the four loudspeakers above. This flexibility can be achieved by installing the EQ cards for the desired setup.

## 4.1 Location and general precautions

Locate the unit where it will not be exposed to rain or moisture. If fluid or a foreign object enters the unit, disconnect the power plug. Do not pull by the cord; grasp the plug firmly. Contact an authorized dealer or service center.

Place the unit where it will be protected from heat and allow adequate ventilation. Place it away from direct heat sources, such as heating vents and radiators. Make sure the ventilation holes are not covered and air can circulate freely behind, beside, and above the unit.

## 4.2 Mechanical considerations

Either amplifier requires two 3.5" rack space units with a 15" depth inside the rack (including the rear supports). Use four screws with washers to prevent marring the front panel. Neoprene rubber washers are a good choice because they grip the screw head and prevent the screws from backing out in the event of vibration or if the unit is transported.

### 4.2.1 Rear support for road applications

If either unit is rack-mounted and the rack is transported, you must mechanically support the rear of the amplifier. You can place a shelf across the rear of the amplifier or brackets in such a way as to support the rear of the unit. This practice is recommended for all electronic instruments.

## 4.3 Thermal considerations

When either amplifier is used free-standing, no thermal considerations are necessary other than keeping the ventilation holes open.

If the unit is rack-mounted, allow for adequate ventilation exits in front of and behind the amplifier. When several amplifiers are mounted together in a rack, you may need to provide air inlets from the outside of the rack.

The unit is fan cooled. The fan is internally mounted so that it draws air in from the front and exhausts it out the rear. This allows cool air from outside the amplifier to flow over and cool the power supply components located in front of the heatsinks.

These amplifiers may be stacked directly on top of each other without spacer panels. If an amplifier is used with other amplifiers, be sure the heat output from each amplifier does not interfere with the ventilation of the others.

## 4.4 AC power considerations

Be sure to plug your amplifier into an outlet capable of supplying the correct voltage specified for your model. Check to be sure there is enough current to allow full-power operation of all the amplifiers in your system.

 The power plug serves as the Main Disconnect device and should always be easily accessible after installation.

The current demand of a power amplifier varies depending on the impedance of the load, the output level of the amplifier, and the crest factor and duty cycle of the program material. For example, consider typical conditions reproducing rock music, with both channels driven into 4 ohms to the point where musical peaks are just at the clipping point.

Under these conditions, the Bose® Model 1800-VI amplifier requires an average of 6.7 amps for 120V versions (3.5 amps for 230V versions).

The Bose Model 1600-VI amplifier requires an average of 4.2 amps for 120V versions (2.2 amps for 230V versions).

## 4.5 Magnetic leakage considerations

You can mount the Bose Model 1800-VI or 1600-VI amplifier without concern for magnetic flux leakage. However, it is not a good idea to mount any power amplifier near a microphone input transformer or magnetic storage media.

## 4.6 Input wiring

You may use 1/4" phone jacks, XLR connectors, and quick connect terminal block connectors for the input signal with either unbalanced 2-conductor or balanced 3-conductor cables. Use shielded coaxial cable to conduct the signal from the source (mixer, equalizer, CD player) to the amplifier.

### 4.6.1 Balanced operation

For the 1/4" phone jack, use a 3-conductor TRS 1/4" phone plug. The tip of the plug carries the + (hot, non-inverting) side of the signal. The ring carries the - (low, inverting) side of the signal. The sleeve is ground (see Figure 1).

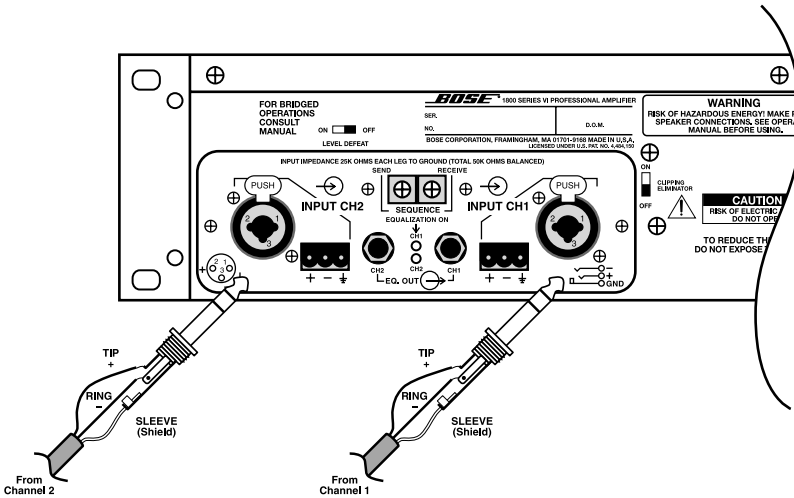

**Figure 1**

1/4" phone jack balanced input connection.

For the XLR, use a male XLR connector. Pin 2 carries the + (hot, non-inverting) side of the signal. Pin 3 carries the - (low, inverting) side of the signal. Pin 1 is ground (see Figure 2).

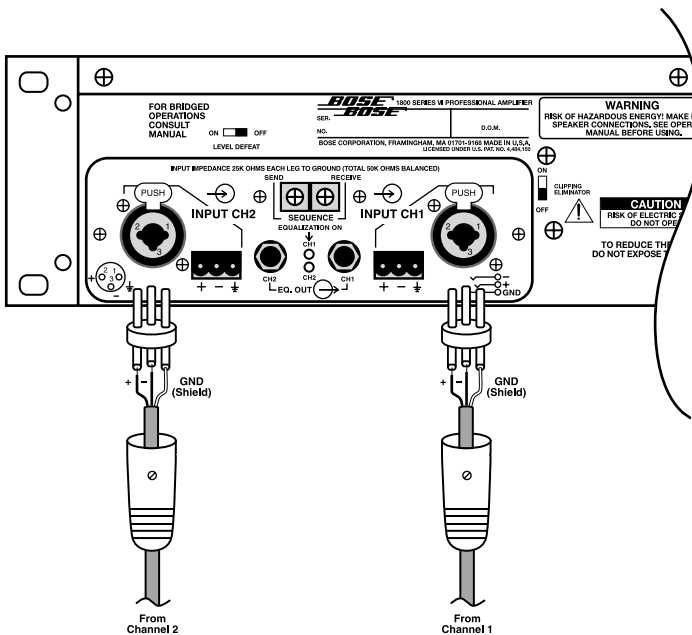
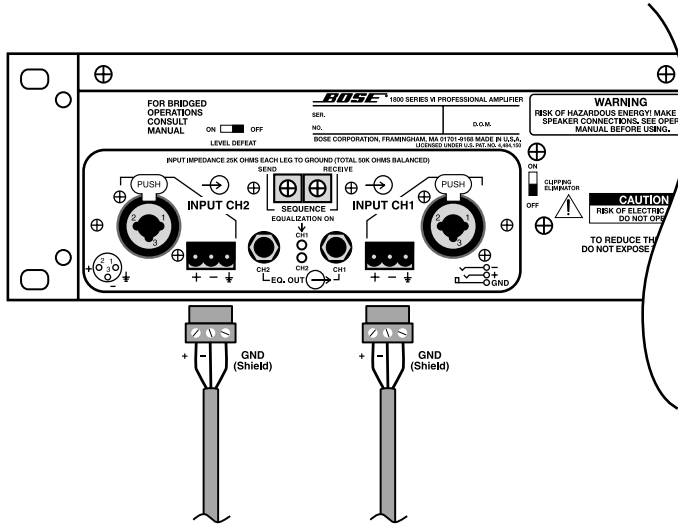

**Figure 2**

XLR balanced input connection.



For the quick connect terminal block, use the female connector provided. Pin 3 carries the + (hot, non-inverting) side of the signal. Pin 2 carries the - (low, inverting) side of the signal. Pin 1 is ground (see Figure 3).



**Figure 3**

Quick connect terminal block balanced input connection.

If you are using the standard input module for either amplifier, the polarity of the balanced inputs can be reversed by changing four jumpers located on the input board, just behind the input connectors. If you are using the ACM-1 module for either amplifier, the polarity cannot be reversed. Refer to page 12 for a description of the different modules.

**4.6.2 Unbalanced operation**

For the 1/4" phone jack, use a 2-conductor (tip-sleeve) 1/4" phone plug. The tip of the plug carries the signal and the sleeve is ground. The ring connection in the jack is automatically grounded by the sleeve (see Figure 4).

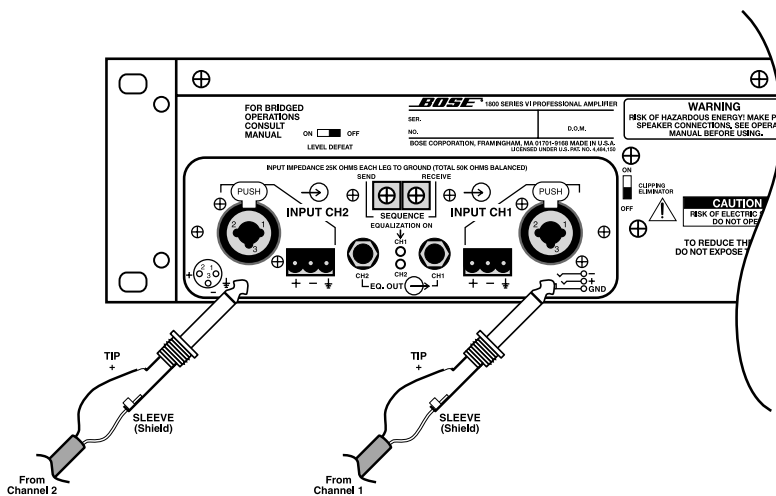
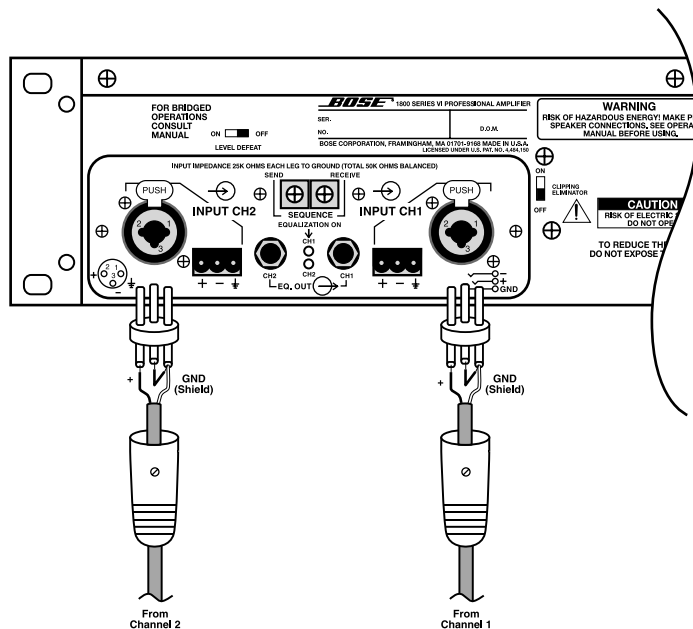

**Figure 4**

1/4" phone jack unbalanced input connection.

## 4.0 Installation

For the XLR, pin 2 carries the + (hot, non-inverting) side of the signal, and pin 1 is ground. To reference the input differential amplifier for the correct gain, short pin 3 to pin 1 (see Figure 5).



**Figure 5**

1/4" XLR unbalanced input connection.

For the quick connect terminal block, pin 3 carries the + (hot, non-inverting) side of the signal, and pin 1 is ground. Short pin 2 to pin 1 in order to reference the input differential amplifier for the correct gain (see Figure 6).

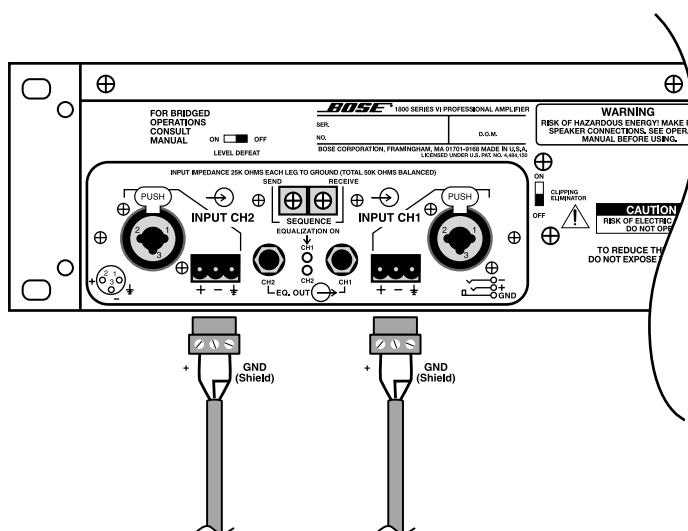

**Figure 6**

Quick connect terminal block unbalanced input connection.

### Note

The gain remains the same regardless of whether the input is balanced or unbalanced.

### 4.7 Input sensitivity

The amplifier input sensitivity is set to 0.775V rms for rated output. To reduce the sensitivity by 6 dB to 1.5V rms, simply remove JP100(CH1) and JP200(CH2), located on the main amplifier board (see Figure 7).

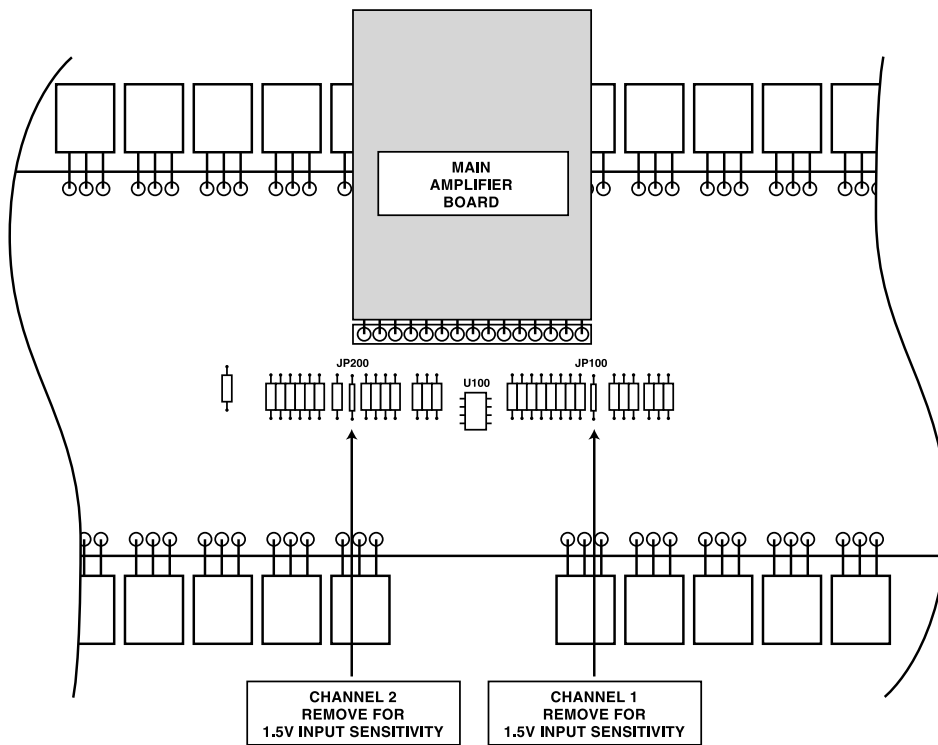

**Figure 7**

Input sensitivity modification.

### 4.8 Output wiring

Use heavy gauge wire for speaker connections. The greater the distance between the amplifier and the speakers, the larger the diameter the wire should be. This will minimize power losses across the wire and improve damping of the speaker. Wire thickness specifications (gauges) get larger as the wire gets thinner. So a 14-gauge wire is thicker than 18-gauge wire. Use the following chart as a guide.

Wire Length	Gauge of Wire
Up to 15'	18 gauge
15' to 25'	16 gauge
25' to 40'	14 gauge
40' to 60'	12 gauge
60' to 100'	10 gauge
100' to 150'	8 gauge
150' to 250'	6 gauge

This will keep the resistance of the speaker wire to less than 5% of 4 ohms and the transmission loss to less than 0.5 dB.

The multi-way binding posts can accept spade lug, bare wire, or banana connections. Be sure all the fine strands of the wire are twisted together and contained within the connector. If even one strand is loose and can touch the adjacent terminal, a short circuit may result. You must use Class I (NEC) wiring.

#### 4.8.1 Polarity

In order to have correct phasing between loudspeakers, you must connect them with consistent polarity. While incorrect phasing will do no physical harm, it will diminish your bass response. The key is to make sure both speakers are connected to the speaker terminals the same way.

Connect – at the speaker outputs to – on the back of the speaker, and + at the speaker outputs to + on the back of the speaker.

#### 4.8.2 Dual mono

The stereo/mono switch is located on the input board behind slot #2 of the standard input module (or, on the AMC-1 module, to the left along the rear edge of the board). For dual-mono operation, move the STEREO/MONO switch all the way to the left to the DUAL setting (or, on the AMC-1 module, move that switch all the way to the right). Connect the input signal to CH 2 input (CH 1 input becomes disabled). Connect the speakers to the speaker outputs on the amplifier just as for normal stereo operation. Both speaker outputs will carry the signal connected to the CH 2 input.

### 4.8.3 Bridged mono

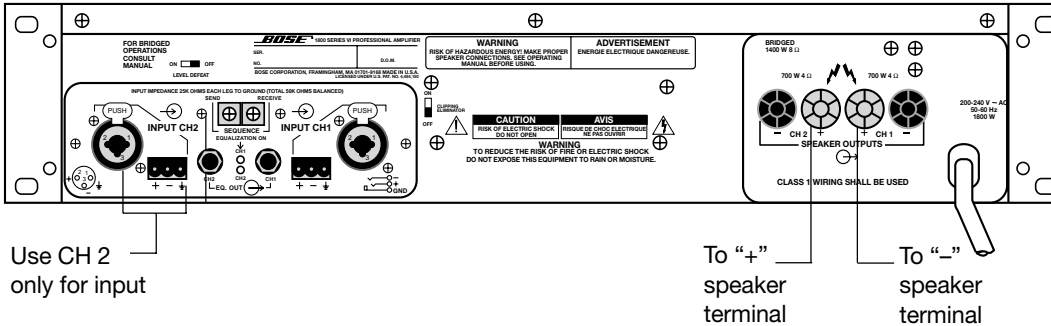

**Figure 8**

Bridged mono connection.

The stereo/mono switch is located on the input board behind slot #2 of the standard input module (or, on the AMC-1 module, to the left along the rear edge of the board). For bridged-mono operation, move the STEREO/MONO switch all the way to the right to the BRIDGED setting (or, on the AMC-1 module, move that switch all the way to the left). Connect the input signal to CH 2 input (CH 1 input becomes disabled). Connect the speakers to the two + speaker terminals. The CH 2 + terminal is the hot (non-inverting) side, and the CH 1 + terminal is the low (-, inverting) side (see Figure 8).

When connected in this way, each channel “sees” half the impedance of the speaker connected between them. If you use an 8 ohm speaker, each channel will see a 4 ohm load. Therefore it is not recommended that you use any load lower than 8 ohms in this mode of operation. Use parallel mono operation for lower impedances.

#### Note

Be sure to set both of the input level controls to the exact same setting for equal power distribution per channel. Switching the level defeat switch (located on the amplifier) to OFF will assure that both channels are operating at the same level.

### 4.8.4 Parallel mono

Parallel mono operation is useful when running sustained high levels in a single load or when driving a low impedance load.

For instructions, contact Bose® or your authorized Bose Professional Products dealer.

## 4.9 Clipping eliminator

This circuit prevents the input signal from exceeding the point where it would drive the amplifier into hard clipping. It has no effect until the signal reaches the clipping point. The larger the input signal, the more it is reduced to keep the output just below clipping.

The clipping eliminator circuit is operational at the point of manufacture. However, you can defeat it by using the clipping eliminator defeat switch. This switch is located on the rear panel of the amplifier. Moving the switch up will re-engage the clipping eliminator.

#### Note

If you turn the input level down far enough, a sufficiently large input signal can drive the input differential amplifier into clipping. The clipping eliminator circuit cannot remedy this. It also has no effect on clipping that occurs prior to the amplifier inputs, such as at the mixer or equalizer.

#### CAUTION

In bridged mono operation, the output connections are actually a balanced output configuration. This means both output terminals have voltage present (neither may be grounded).

### 5.1 Using the Bose® Model 1800-VI or 1600-VI Professional Stereo Power Amplifier

Once you have installed and wired the amplifier, follow these tips to get the most from it.

**Verify** all switches (stereo/mono, clipping eliminator, EQ Bi-Amp/Full Range and level defeat) are set to the mode you want.

**Turn down** the amplifier controls when you power up the system for the first time. Then advance them slowly, one at a time, to verify that each channel is operating correctly.

**Set input level controls** high enough to allow the preceding device to drive the amplifier to full output. Usually, this is wide open (fully clockwise).

**Mark down** the settings, either on paper or self-stick dots attached to the front of the amplifier.

**In bi-amplified (multi-amp) systems**, start with the low frequency amps turned down or off. Check each frequency range from highest to lowest to make sure each loudspeaker component is operating correctly.

### 5.2 Input Modules

#### 5.2.1 Standard input module

Through the use of Bose input module (the standard module provided with the amplifier) and equalization cards, Bose Model 1800-VI or 1600-VI amplifiers can provide active equalization for Bose 402®, 502®A, 502B, and 802® professional loudspeakers.

Each channel of the input module has its own equalizer card input connector, which allows different equalization for each channel (provided the correct EQ card is installed). For a view of the input module, refer to Figure 10 on page 16.

A sample set up might involve one Model 1800-VI amplifier driving two channels of 502A loudspeakers in stereo mode. A second Model 1800-VI amplifier could be added to drive a 502B module. Alternatively, just one amplifier could be used to drive the 502A loudspeakers on one channel and the 502B module on the other channel. Many configurations are possible using the four loudspeakers above. This flexibility can be achieved by installing the EQ cards for the desired setup. For a view of the ACM-1 module, refer to Figure 11 on page 16.

#### 5.2.2 ACM-1 amplifier control module

The Bose ACM-1 amplifier control module is designed to establish network control of the Bose 1800-VI or 1600-VI amplifier. This network link makes remote operation of signal level and power on/off functions possible. The module also provides amplifier monitoring capability. Using the graphical user interface of the ACM-1 module software, settings like amplifier output, amplifier load, temperature, and clip levels can be checked routinely. Refer to the ACM-1 installer's guide for complete installation instructions.

### 5.3 Front Panel

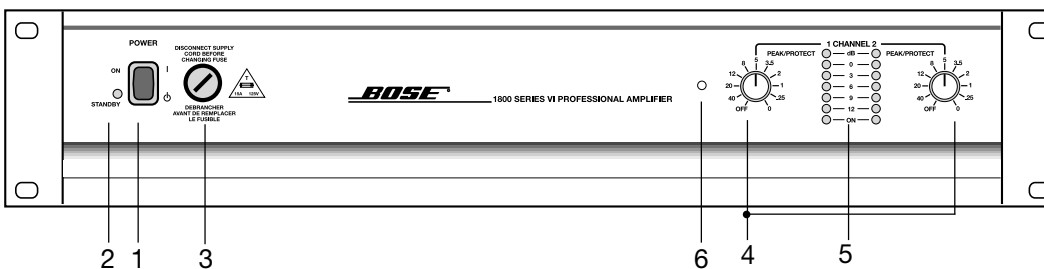

**Figure 9**

Front panel of the 1800-VI amplifier (generally identical to the 1600-VI amplifier front panel)

- |                  |                           |
|------------------|---------------------------|
| 1. Power switch  | 4. Level controls         |
| 2. Standby LED   | 5. Status indicators      |
| 3. AC power fuse | 6. Data receive indicator |

### 5.3.1 Power switch



The power switch is used as a functional switch and should not be relied upon as a safety disconnect.

**100 volt and 120 volt versions:** Press to turn the power ON or on STANDBY. When ON, the READY indicators will illuminate. In the STANDBY mode, the unit is off but can be activated through the SEQUENCE connector on the rear panel of the amplifier. Be sure all connections are made and double checked before switching the power amplifier ON.

#### Note

*Standby (see above) and Sequencing (see below) modes are activated at the amplifier only when using the standard input module. For the ACM-1 module, these modes are established via the network. For further detail, refer to instructions included with the network.*

**220-240 volt version:** This version has separate POWER and SEQUENCE switches on the front panel. Press the POWER switch to turn power on (1) or off (0). When the unit is off, no power reaches the unit and the sequencing function is not active. To use the amplifier in the normal mode, set the POWER switch on and set the SEQUENCE switch to the off position (⬇). The READY indicators will illuminate. To activate the sequencing function, the SEQUENCE switch must *first* be switched to the on position (⬆) and *then* the POWER switch must be turned on. The unit will then be in a standby mode and can be activated by the sequence signal. See Section 5.4.8 for additional information regarding the sequence feature.

### 5.3.2 Standby LED

Illuminates when the power switch is turned OFF to indicate the amplifier is connected to AC power and the amplifier can be powered up. When the power switch is ON, the standby LED turns off.

### 5.3.3 AC power fuse

Protects the amplifier from catastrophic failures that could damage internal circuitry. Repeated fuse blowing is a sign of internal distress. Refer to an authorized Bose® Service Center for evaluation.

#### CAUTION

*Always replace with the same type and value fuse indicated next to the fuse holder.*

### 5.3.4 Level controls

Used to adjust the input level of each channel. When fully clockwise, the amplifier operates at maximum gain. Turning the controls counter-clockwise attenuates the input signal.

You can bypass the Level controls internally to lock the amplifier at its full gain capacity. See the Note about the level defeat switch on page 13.

### 5.3.5 Status indicators

The ON LED illuminates green when the power is on and the amplifier is ready to operate. The ON LED illuminates red when the power switch is first turned on (while the power supply is stabilizing prior to the speaker output relays switching in) or when the amplifier is in protect mode.

The five SIGNAL LEDs illuminate yellow when a signal is present at the speaker output jacks to indicate output power relative to full power (0 dB).

The PEAK/PROTECT LED illuminates red when the power switch is first turned on, when the output begins to clip, or whenever there is a fault condition that causes the output relays to disengage. These fault conditions include excessive DC offset, excessive heatsink temperature, and short circuits at the speaker outputs.

#### Note

*The relays operate independently for each channel. Therefore, it is possible for one channel to operate normally while the other is in protect mode.*

### 5.3.6 Data receive indicator

Flashes a yellow light when an installed ACM-1 module is receiving network information.

### 5.4 Rear panel (see Figures 10 & 11)

#### 5.4.1 Stereo/mono switch

Located on the motherboard of the input module, this switch selects between NORMAL STEREO, DUAL MONO, or BRIDGED MONO operation.

For NORMAL STEREO operation, use CH 1 and CH 2 inputs. For DUAL MONO or BRIDGED MONO operation, use CH 2 input only. See the section on bridged operation for more information.

#### 5.4.2 Clipping eliminator switch

You can bypass the clipping eliminator circuit with this switch (located just to the right of the input panel). Turning the switch OFF deactivates the clipping eliminator and allows the amplifier to clip when driven beyond its maximum output capability. The clipping eliminator is operational at the point of manufacture (switch in the up position). For more information on how the clipping eliminator circuitry works, see Section 4.9.

#### 5.4.3 Input connectors

There are two input connectors per channel which enable three different types of input connectors to be used. A combination 1/4" TRS (Tip-Ring-Sleeve)/XLR input connector on the input module allows for either a 1/4" TRS input or a XLR input. A quick connect terminal block input is also on the input module and is wired in parallel with the TRS/XLR input connector. This allows for easy connection of stripped wires to a connector which is provided. Two parallel input connectors allow for simple connection of parallel amplifiers.

#### Note

When in mono mode, use CH 2 input only.

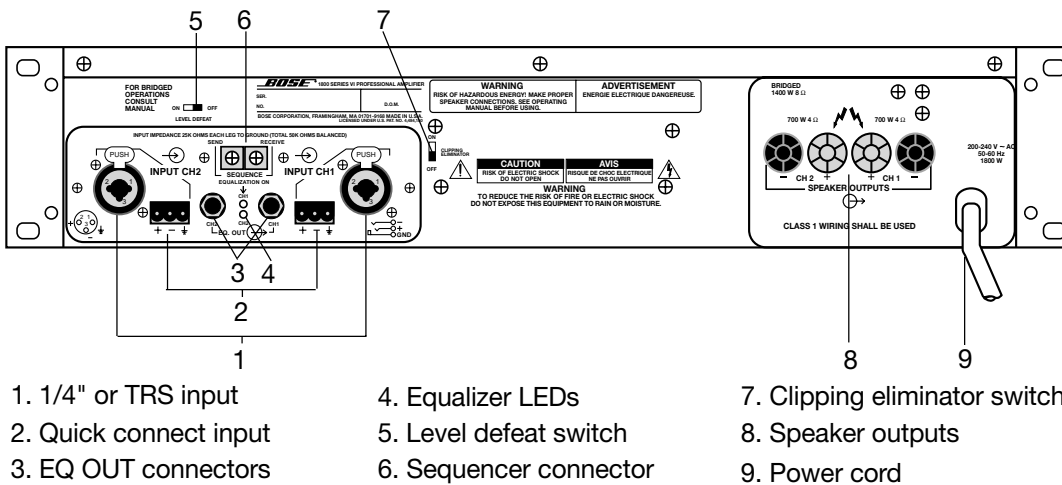

**Figure 10**

Rear panel of the 1800-VI amplifier with the standard input module installed.

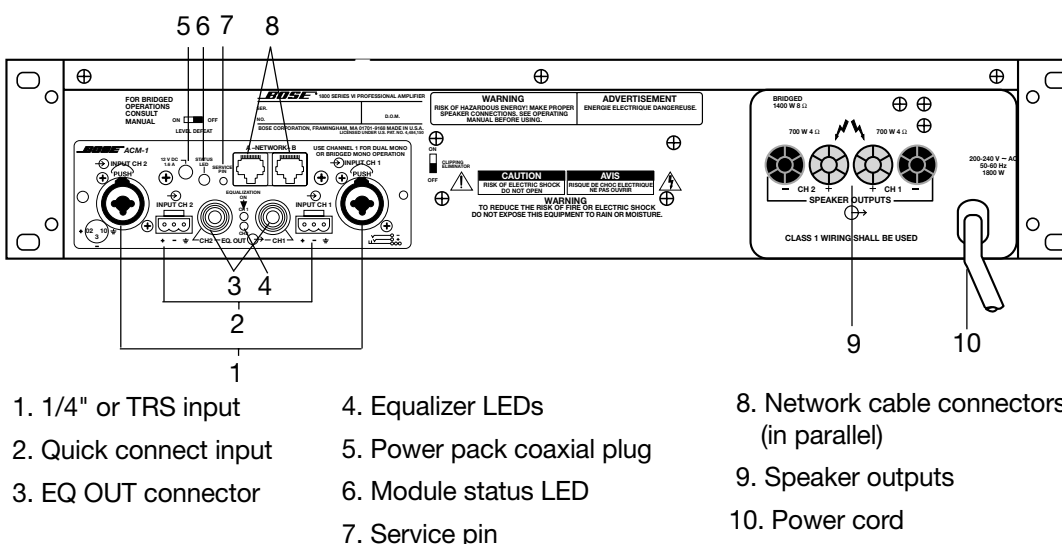

**Figure 11**

Rear panel of the 1800-VI amplifier with the ACM-1 module installed.



#### 5.4.4 EQ OUT connectors

A 1/4" TRS output connector provides access to an equalized line level output signal for each channel. If equalizer cards are installed, this signal has passed through the internal equalizer, but has not passed through the amplifier itself. (For additional information on equalization cards, see Input Modules on page 14.)

This is helpful if several devices are going to be driving similar Bose® loudspeakers (802® loudspeakers, for example) with the same source signal. With equalization cards installed in the Model 1800-VI or 1600-VI amplifier, the EQ OUT of the amplifier can be connected to the line level inputs of additional devices driving the same type Bose loudspeakers (i.e. 802). The type of equalizer cards used must correspond to the type of loudspeakers.

#### 5.4.5 Equalizer LEDs

You can install equalizer cards on the motherboard of the input module by removing the input module. When you install an equalizer card, the corresponding LED illuminates to indicate the presence of the card.

Each channel can utilize a different card. For example, the Bose Model 1800-VI Professional Stereo Power Amplifier can have both a 402® and a 502®B equalizer card installed. When you install a 502B card in either card position, it automatically selects the high frequency output of the other card. When a system uses two or more amplifiers, and you are using a 502B module, use the EQ Bi-Amp/Full Range switch to run in the bi-amp mode.

#### Note

*When equalizer cards are installed, the input module automatically senses the cards and switches to the equalizer circuitry. If no cards are installed, the input module bypasses the equalizer circuitry.*

#### 5.4.6 EQ Bi-Amp/Full Range switch

This switch is located on the motherboard of the input module. The module must be removed to access this switch. To select the high frequency output from both equalizer cards, engage this switch (HF ONLY position). The high pass filter begins reducing the signal below 140 Hz and allows the same equalizer card to be used for full range output and bi-amp output. This feature is useful when using two or more amplifiers and a 502B module.

#### 5.4.7 Level defeat switch

This switch is located above the input module and defeats the CHANNEL 1 and CHANNEL 2 LEVEL controls. When the controls are defeated (switch moved to the left) the amplifier gain is set at the maximum level. The module must be removed to access this switch.

#### 5.4.8 Sequencer connector

This feature is helpful if you are using many amplifiers since it allows amplifiers to sequentially power up. This reduces the initial surge currents from the AC power source to avoid tripping circuit breakers. The SEND connector of one amplifier is connected to the RECEIVE connector of the next amplifier. Turn the master power off by switching the equipment rack, circuit breaker or other main power switch off. The first amplifier in the chain should be in the normal on position. The subsequent amplifiers should be in the standby mode. When the master power is turned on, the amplifiers will sequentially power up. For additional information on switch settings, see Section 5.3.1.

**5.4.9 Speaker outputs**

Multi-way binding posts connect the loudspeakers to the amplifier outputs. The red terminals are the signal connection (+) and the black terminals are the signal return connection (-). The black terminals are internally tied together and to signal ground. See Section 4.8 for additional output wiring information.

**Note**

Only connect the Bose® model loudspeaker corresponding to the EQ card installed in the input module. Use of a different loudspeaker may result in permanent damage to the loudspeakers.

**5.4.10 Power cord**

Connect to a properly configured outlet providing the line voltage specified for your model.

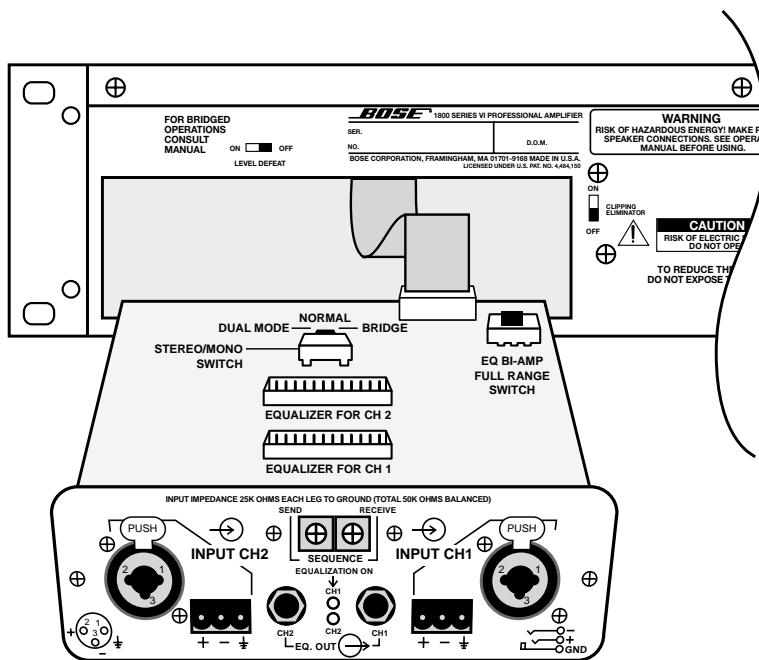

**Figure 12**

Operational modifications using the standard input module.

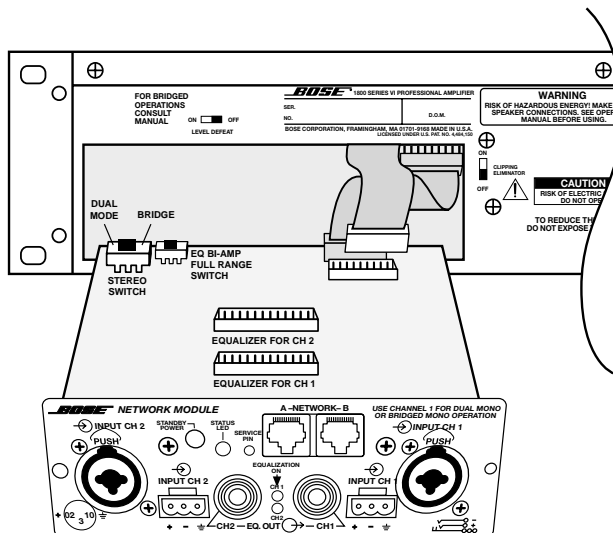

**Figure 13**

Operational modifications using the ACM-1 module.

## Problems/solutions

If you are having trouble or suspect a problem with the Bose® Model 1800-VI or 1600-VI Professional Stereo Power Amplifier, try some simple troubleshooting before contacting an authorized Bose Service Center.

<b>Problem</b>	<b>What to do</b>
<p>No sound, no power</p> <p>(Usually an indication of a power supply problem, either in the power line itself or the amplifier's power supply.)</p>	<ul style="list-style-type: none"> <li>• Amplifier power off. Turn on.</li> <li>• Linecord disconnected.</li> <li>• Poor fit between the plug and AC receptacle. Try another receptacle.</li> <li>• Power off at AC receptacle. Check with tester or lamp.</li> <li>• Blown amplifier fuse. Replace fuse.</li> <li>• Open thermal breaker in the power transformer. Allow amplifier to cool and the breaker will reset itself.</li> </ul>
<p>Power on, low output or no output</p> <p>(Usually signal-source, bad cable or partial output short circuit related.)</p>	<ul style="list-style-type: none"> <li>• Input level controls set too low. Reset.</li> <li>• Check to see if problem is at the source. Move the input connections to another amplifier you know is working.</li> <li>• Be sure that there are no small strands of wire touching similar strands coming from the other wire in the cable.</li> <li>• Make sure the speakers are functioning correctly.</li> <li>• If you are using bridged-mono mode, make sure the stereo/mono switch is set correctly.</li> <li>• Use a voltmeter to determine if the power line voltage is dropping excessively when the amplifier is driven hard.</li> </ul>
<p>Playback mixed with hum</p>	<ul style="list-style-type: none"> <li>• Check or replace the connecting cables.</li> <li>• Make sure that each screw terminal connection is tight.</li> <li>• Signal cables may have been routed too closely to AC cables, power transformers, motors or other EMI inducing device.</li> <li>• Connect another source to the power amplifier inputs. If the hum stops, the problem lies with the original source component.</li> </ul>
<p>Distortion</p> <p>(Usually caused by excessive loss in the input controls when the mixer/equalizer/crossover does not produce enough output. Also caused by over-driving that results in output clipping, or current limiting caused by excessively low load impedances.)</p>	<ul style="list-style-type: none"> <li>• Check input level controls. If set too low, the preceding piece of equipment may not have sufficient output to overcome the loss.</li> <li>• Check speaker connections and verify that all screw connections are tight and that there are no stray strands of wire to cause short circuits.</li> <li>• Verify that the total load impedance presented to the amplifier is within the limits described in this manual for the mode of operation selected.</li> </ul>
<p>Unnatural sound</p> <p>(Some parts of the frequency band do not sound balanced with the rest of the band.)</p>	<ul style="list-style-type: none"> <li>• Check the EQ cards. Verify that the EQ card corresponds to the model speaker being used and that the EQ card is installed in the proper channel. Verify that the speakers are connected to the same channel that the corresponding EQ card is installed in.</li> </ul>
<p>Care</p>	<ul style="list-style-type: none"> <li>• Wipe the front panel and chassis with a soft, dry cloth.</li> <li>• For stubborn spots, use a mild dish soap or detergent sparingly applied to a soft cloth.</li> <li>• Don't use alcohol, ammonia, or other strong solvents.</li> </ul>

### **Features of the Bose® Model 1800-VI and 1600-VI Professional Stereo Power Amplifiers**

#### **1800-VI amplifier**

450 watts per channel into 8 ohms

600 watts per channel into 4 ohms

Two input connectors per channel allow 1/4" TRS, XLR, or quick connect terminal block connection

Two input connectors for each channel are wired in parallel

Accepts balanced or unbalanced lines

Independent CH 1 and CH 2 Level controls with 11 detented positions

Level Control Defeat Switch

Dual Mono mode for operating both channels with a single mono input

Bridged Mono mode for combining the power of both channels into a single higher powered channel

Sequencer connection for sequentially powering-up multiple amplifiers

Active equalization cards available for the Bose 402®, 502®A, 502B, and 802®, Model 8 and Model 25/32 loudspeakers.

Bi-Amp/Full Range configurable

Internally configurable for Parallel Mono mode for single channel low impedance operation

Internally configurable for 0.775V or 1.5V rms input sensitivity

Internally configurable input polarity

Class H dual-rail power supply

Independent CH 1/CH 2 speaker relays will instantly disconnect if one of the following fault conditions is detected: D.C. offset, over temperature, short circuit

Additional protection circuitry includes Clipping Eliminator, AC Line Fuse

Power Connected/Standby indicator

7 LED display per channel, including Power Ready and Clip/Protect indicators

2-speed fan cooled

#### **1600-VI amplifier**

240 watts per channel into 8 ohms

325 watts per channel into 4 ohms

**Warranty period**

Bose® warrants the Bose Model 1800-VI and Model 1600-VI Professional Stereo Power Amplifier with a five-year, transferable, limited warranty. For more information, please read the warranty card.

**Service**

If you experience problems with your Bose Model 1800-VI or 1600-VI Professional Stereo Power Amplifier, contact your authorized Bose Professional Products dealer. The dealer will verify any defects and arrange for service.

Please complete the owner's registration card included with this guide. Return it to Bose within ten days of purchase.

### Specifications for Bose® Model 1800-VI and 1600-VI Professional Stereo Power Amplifiers

#### Model 1800-VI amplifier

##### Power Output

Continuous Average Output Power, both channels driven:

450 watts per channel into 8 ohms from 20 Hz to 20 kHz, with no more than 0.2% THD

600 watts per channel into 4 ohms from 20 Hz to 20 kHz, with no more than 0.2% THD

Bridged-mono operation:

1400 watts into 8 ohms from 20 Hz to 20 kHz, with no more than 0.2% THD

##### Voltage Output

60V line voltage per channel into 8 ohms

49V line voltage per channel into 4 ohms

##### Dynamic Headroom

1.0 dB nominal

##### Gain

High 36.0 dB ( $\pm 0.5$  dB)

Low 30.3 dB ( $\pm 0.5$  dB)

##### Signal-To-Noise Ratio

>100 dB, A-weighted, referenced to rated power into 4 ohms (High gain)

>78 dBW, A-weighted, referenced to 1W into 4 ohms (High gain)

##### Power Consumption

55W at idle

800W with musical program

1500W at full power into 8 ohms (continuous)

2400W at full power into 4 ohms (continuous)

##### Fusing

15 amp slo-blo (120V/60 Hz)

8 amp slo-blo (230V/50 Hz)

##### Weight

Net 33 lb (15.0 kg)

Shipping 39 lb (17.7 kg)

#### Model 1600-VI amplifier

##### Power Output

Continuous Average Output Power, both channels driven:

240 watts per channel into 8 ohms from 20 Hz to 20 kHz, with no more than 0.2% THD

325 watts per channel into 4 ohms from 20 Hz to 20 kHz, with no more than 0.2% THD

Bridged-mono operation:

700 watts into 8 ohms from 20 Hz to 20 kHz, with no more than 0.2% THD

##### Voltage Output

43.8V line voltage per channel into 8 ohms

36.0V line voltage per channel into 4 ohms

##### Dynamic Headroom

2.0 dB nominal

##### Gain

High 33.3 dB ( $\pm 0.5$  dB)

Low 27.6 dB ( $\pm 0.5$  dB)

##### Signal-To-Noise Ratio

>100 dB, A-weighted, referenced to rated power into 4 ohms (High gain)

>79 dBW, A-weighted, referenced to 1W into 4 ohms (High gain)

##### Power Consumption

45W at idle

500W with musical program

1000W at full power into 8 ohms (continuous)

1550W at full power into 4 ohms (continuous)

##### Fusing

10 amp slo-blo (120V/60 Hz)

7 amp slo-blo (230V/50 Hz)

##### Weight

Net 30 lb (13.6 kg)

Shipping 36 lb (16.3 kg)

Features and specifications are subject to change without notice.

**Model 1800-VI amplifier sensitivity***High (at 1 kHz)*

0.775V rms for rated power into 4 ohms

32mV rms for 1W into 4 ohms

*Low (at 1 kHz)*

1.5V rms for rated power into 4 ohms

61mV rms for 1W into 4 ohms

**Model 1600-VI amplifier sensitivity***High (at 1 kHz)*

0.775V rms for rated power into 4 ohms

43mV rms for 1W into 4 ohms

*Low (at 1 kHz)*

1.5V rms for rated power into 4 ohms

83mV rms for 1W into 4 ohms

**Specifications common to both amplifiers****Power Bandwidth**

5 Hz to 40 kHz (+0, -3 dB)

**Frequency Response**20 Hz to 20 kHz ( $\pm 0.75$  dB)**Input Impedance**

25 kilohms unbalanced, each leg to ground, 50 kilohms balanced

**Channel Separation**

&gt; 65 dB @ 1 kHz

&gt; 55 dB @ 10 kHz

**Input Overload**

+18 dBu

**IM Distortion**

&lt; 0.1%

**THD**

@ 0.775V Sensitivity &lt; 0.2%

@ 1.5V Sensitivity &lt; 0.1%

**Slew Rate**10V/ $\mu$ S (Bandwidth limited)40V/ $\mu$ S (RFI filtering removed)**CMRR**> 80 dB @ 1 kHz (without Bose<sup>®</sup> input module)

&gt; 60 dB from 20 Hz-20 kHz (without Bose input module)

**Power Requirements**

120VAC/50-60 Hz

220-240VAC/50-60 Hz

100VAC/50-60 Hz

**Note***Make sure your outlet is capable of supplying the correct voltage specified for your model.***Display**

7 LED indicators per channel

1 green READY, 5 yellow SIGNAL, 1 red CLIP/PROTECT

**Size (H x W x D)**

3.5" (2U) x 19" x 13.25"

89mm x 483mm x 337mm





**USA**

Bose Corporation, The Mountain  
Framingham, MA 01701-9168  
1-800-367-4008  
Phone hours - ET (eastern time):  
Weekdays 8:30 a.m. to 8:00 p.m.  
Saturdays 9 a.m. to 3 p.m.

**Canada**

Bose Ltd., 1-35 East Beaver Creek Road  
Richmond Hill, Ontario L4B 1B3  
1-800-465-2673  
Phone hours - ET (eastern time):  
Weekdays 9:00 a.m. to 5:00 p.m.

**European Office**

Bose Products B.V., Nijverheidstraat 8  
1135 GE Edam, Nederland  
TEL 0299-390111 FAX 0299-390114

**Australia**

Bose Pty Limited  
1 Sorrell Street  
Parramatta NSW, 2150  
TEL 02 9204-6111 FAX 02 9204-6122

**Belgique/België**

Bose N.V., Limesweg 2, B-3700 Tongeren  
TEL 012-390800 FAX 012-390840

**Danmark**

Bose A/S, Industrivej 7, 2605 Brøndby  
TEL 4343-7777 FAX 4343-7818

**Deutschland**

Bose GmbH, Max-Planck-Straße 36d  
D-61381 Friedrichsdorf  
TEL 06172-71040 FAX 06172-710419

**France**

Bose S.A., 6, rue Saint Vincent  
78100 Saint Germain en Laye  
TEL 01-30616363 FAX 01-30614105

**India**

Bose Corporation India Private Limited  
W-16, Greater Kailash-II  
New Delhi 110 048  
TEL (011) 648 4462 FAX (011) 648 4463

**Ireland**

Bose Corporation  
Carrickmacross, Co Monaghan  
TEL (042) 9661988 FAX (042) 9661998

**Italia**

Bose s.p.A., Via della Magliana 876  
00148 Roma  
www.bose.it  
TEL 06-65670802 FAX 06-65680167

**Japan**

Bose K.K., Shibuya YT Building  
28-3 Maruyama-cho  
Shibuya-ku, Tokyo 150  
TEL 3-5489-0955 FAX 3-5489-0592

**Nederland**

Bose B.V., Nijverheidstraat 8  
1135 GE Edam  
TEL 0299-390139 FAX 0299-390109

**Norge**

Bose A/S, Solheimsgate 11  
N-2001, Lillestrøm  
TEL 63-817380 FAX 63-810819

**Österreich**

Bose Ges.m.b.H., Vienna Business Park  
Wienerbergstrasse 7 (10.OG)  
A-1100 Vienna  
TEL 01-60404340 FAX 01-604043423

**Schweiz**

Bose AG, Rünenbergerstrasse 13  
4460-Gelterkinden  
TEL 061-9815544 FAX 061-9815502

**Sverige**

Bose A/S, JohanneFredsgatan 4  
S-43153 Mölndal  
TEL 31-878850 FAX 31-274891

**United Kingdom**

Bose Limited  
1 Ambley Green  
Gillingham Business Park  
Gillingham, Kent ME8 ONJ  
TEL 0870-741-4500 FAX 0870-741-4545

**From other locations**

Bose Customer Service, 1 New York Ave.  
Framingham, MA 01701-9168 USA  
TEL (508) 766-1900 FAX (508) 766-1919

**World Wide Web**

www.bose.com



***BOSE***<sup>®</sup>  
*Better sound through research.*<sup>®</sup>

©2000 Bose Corporation  
The Mountain, Framingham  
MA 01701-9168 USA  
198352 AM Rev.02W JN10421  
PC023298